

LBCR 30-2LS SKF

Linear bushing

TYPE: Shaft guidance systems, Linear bushing, Standard, Close type, Type LBE..UU, KB..PP, LBCR..2LS, sealed on both sides

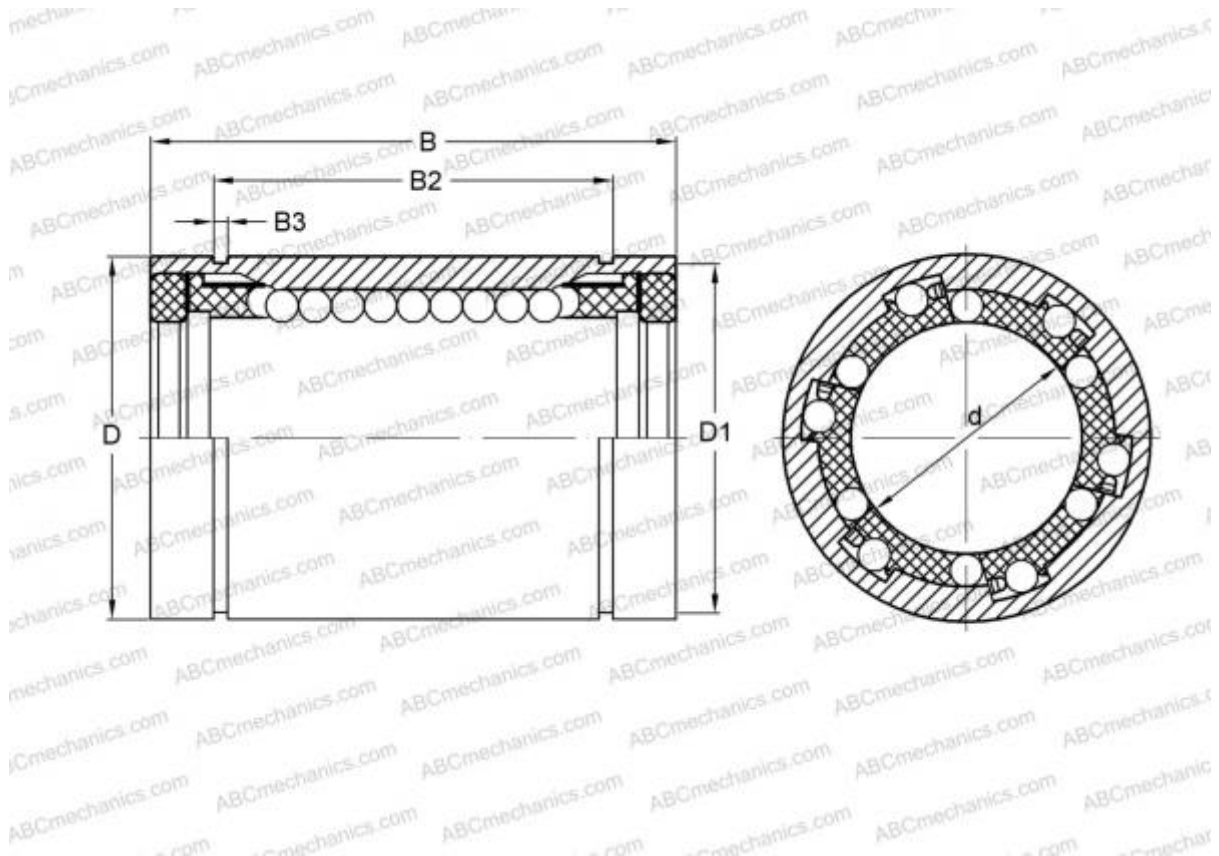

Technical specification

DIMENSIONS, MM

d	30,000
D	47,000
B	68,000

WEIGHT, KG 0,305

MANUFACTURER [SKF](#)

INTERCHANGE

ABC	LBE 30 UU
IKO	LBE 30 UU
STAR	0602-030-10
THOMSON	0602-030-10
INA	KB30-PP
FAG	LAA 30x47x68.2RS