

0602-040-10 STAR

Linear bushing

TYPE: Shaft guidance systems, Linear bushing, Standard, Close type, Type LBE..UU, KB..PP, LBCR..2LS, sealed on both sides

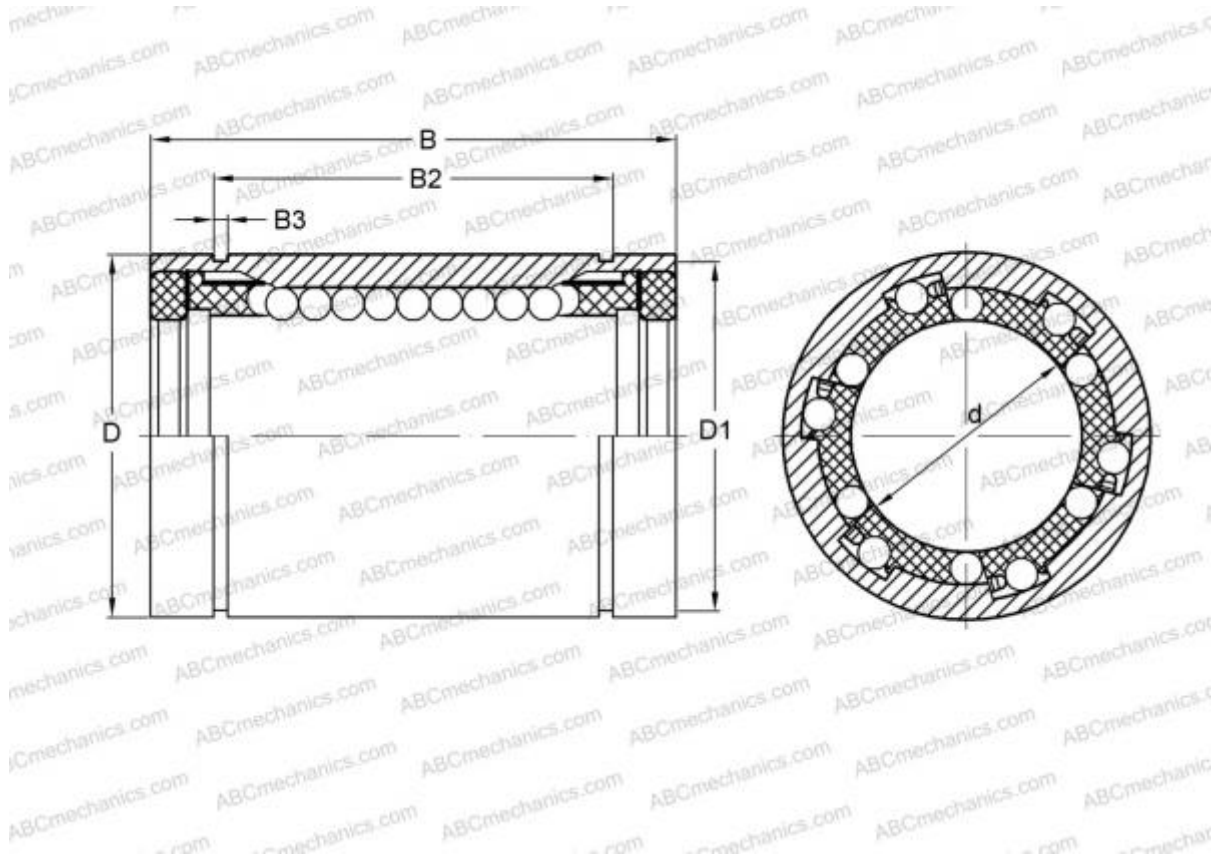

Technical specification

DIMENSIONS, MM

d	40,000
D	62,000
B	80,000

WEIGHT 0,555

MANUFACTURER [STAR](#)

INTERCHANGE

ABC	LBE 40 UU
IKO	LBE 40 UU
THOMSON	0602-040-10
INA	KB40-PP
SKF	LBCR 40-2LS
FAG	LAA 40x62x80.2RS