

0612-016-10 STAR

Linear bushing

TYPE: Shaft guidance systems, Linear bushing, Standard, Adjustable type, Type LBE..UU AJ, sealed on both sides

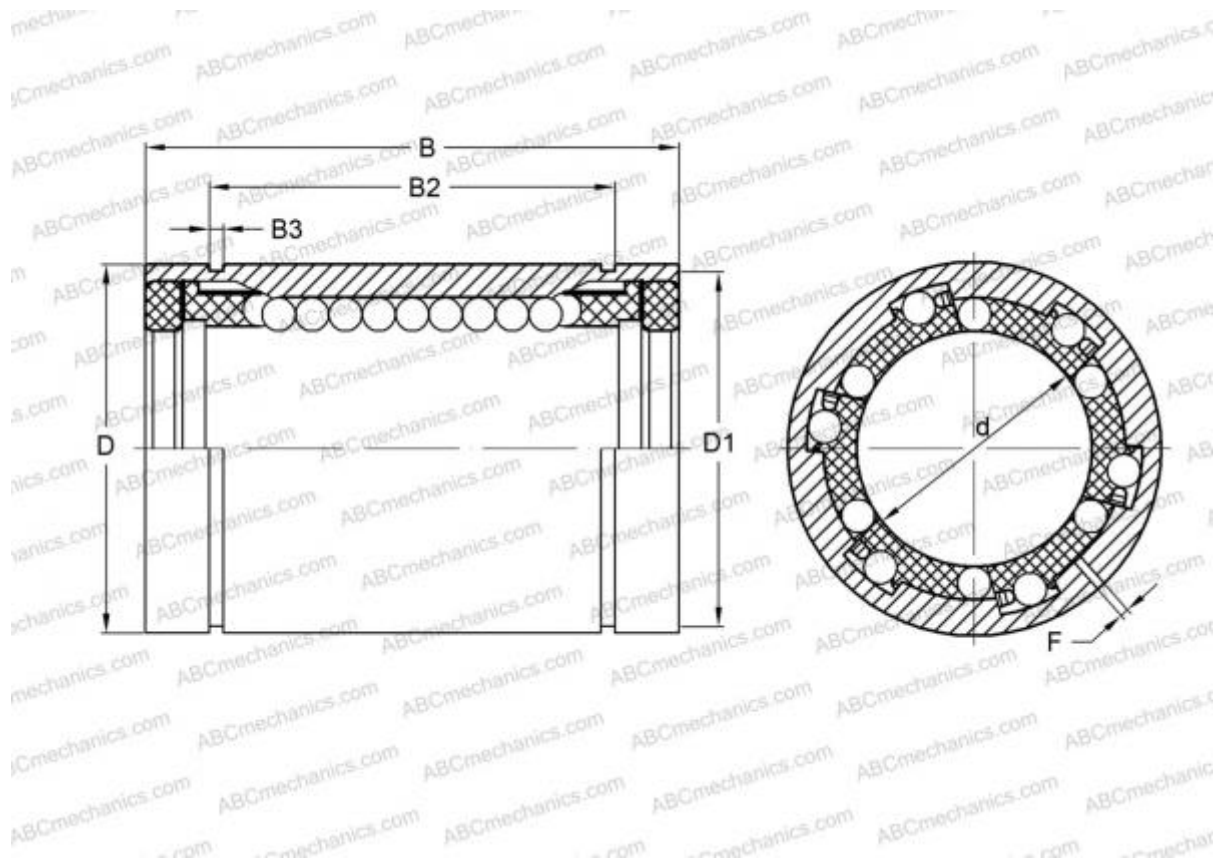

Technical specification

DIMENSIONS, MM

d	16,000
D	26,000
B	36,000
F	1.5

WEIGHT, KG 0,047

MANUFACTURER [STAR](#)

INTERCHANGE

ABC	LBE 16 UU AJ
IKO	LBE 16 UU AJ
THOMSON	0612-016-10
INA	KBS16-PP
FAG	LAG 16x26x36.2RS