

0612-025-10 STAR

Linear bushing

TYPE: Shaft guidance systems, Linear bushing, Standard, Adjustable type, Type LBE..UU AJ, sealed on both sides

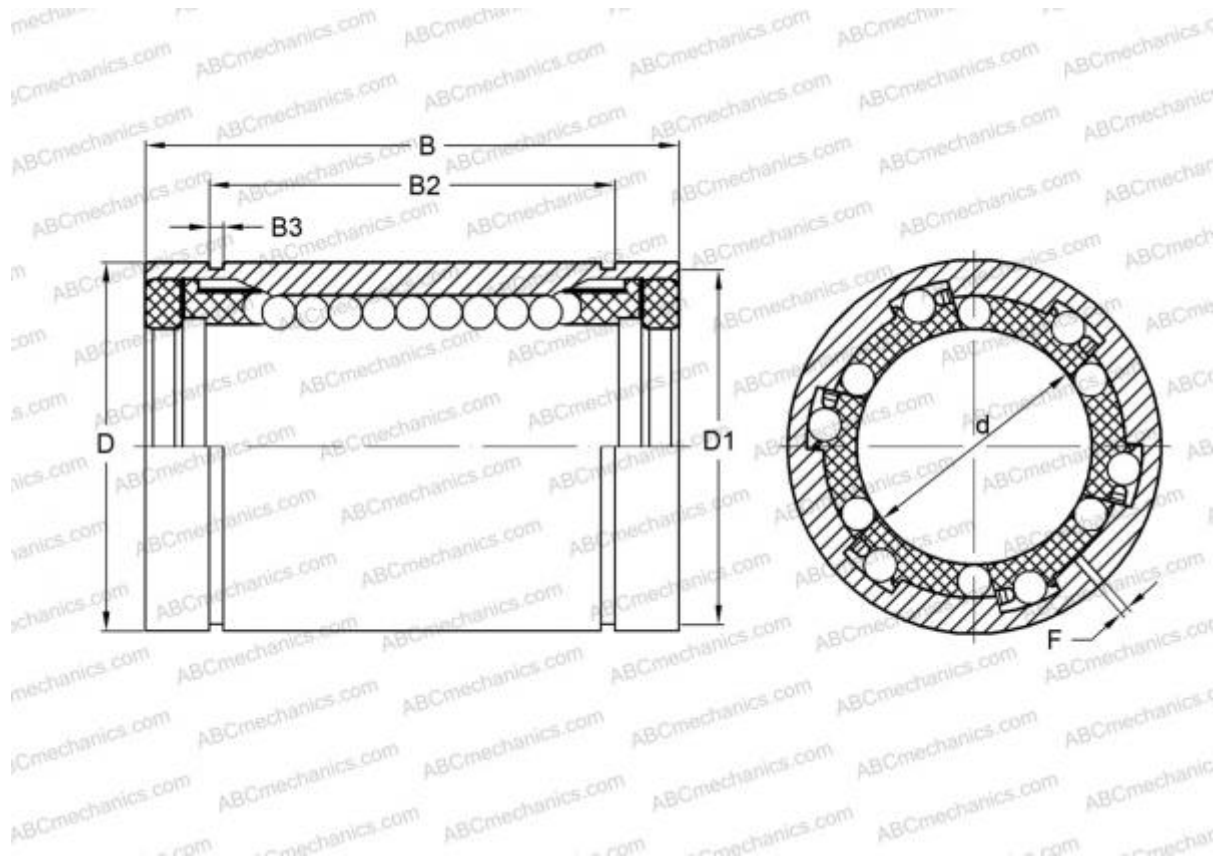

Technical specification

DIMENSIONS, MM

d	25,000
D	40,000
B	58,000
F	2

WEIGHT, KG 0,160

MANUFACTURER [STAR](#)

INTERCHANGE

ABC	LBE 25 UU AJ
IKO	LBE 25 UU AJ
THOMSON	0612-025-10
INA	KBS25-PP
FAG	LAG 25x40x58.2RS