

LBE 30 UU AJ ABC

Linear bushing

TYPE: Shaft guidance systems, Linear bushing, Standard, Adjustable type, Type LBE..UU AJ, sealed on both sides

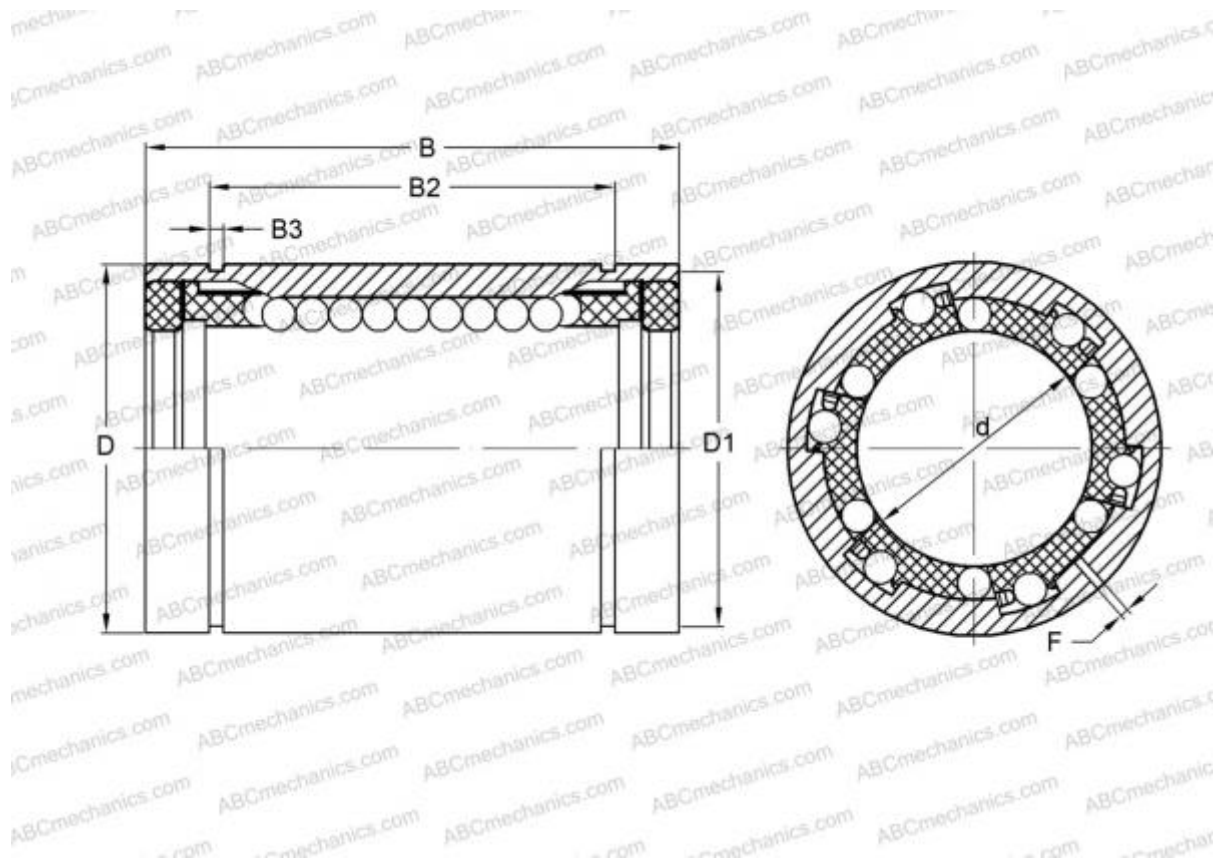

Technical specification

DIMENSIONS, MM

d	30,000
D	47,000
B	68,000
F	2

WEIGHT, KG 0,305

MANUFACTURER [ABC](#)

INTERCHANGE

IKO	LBE 30 UU AJ
STAR	0612-030-10
THOMSON	0612-030-10
INA	KBS30-PP
FAG	LAG 30x47x68.2RS