

0612-040-10 THOMSON

Linear bushing

TYPE: Shaft guidance systems, Linear bushing, Standard, Adjustable type, Type LBE..UU AJ, sealed on both sides

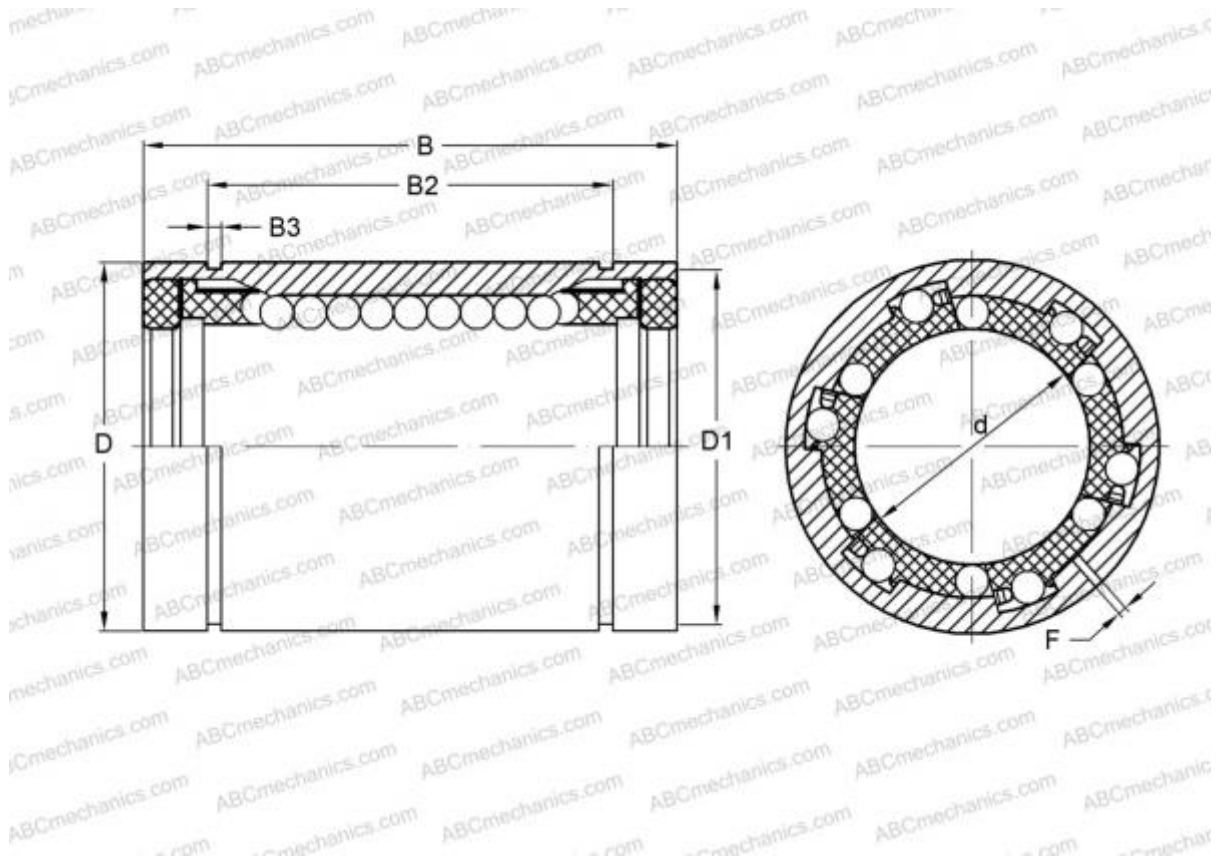

Technical specification

DIMENSIONS, MM

d	40,000
D	62,000
B	80,000
F	2

WEIGHT 0,555

MANUFACTURER [THOMSON](#)

INTERCHANGE

ABC	LBE 40 UU AJ
IKO	LBE 40 UU AJ
STAR	0612-040-10
INA	KBS40-PP
FAG	LAG 40x62x80.2RS