

KBS25-PP INA

Linear bushing

TYPE: Shaft guidance systems, Linear bushing, Self aligning, Close type, Type KBS..PP, machined range, sealed on both sides (INA)

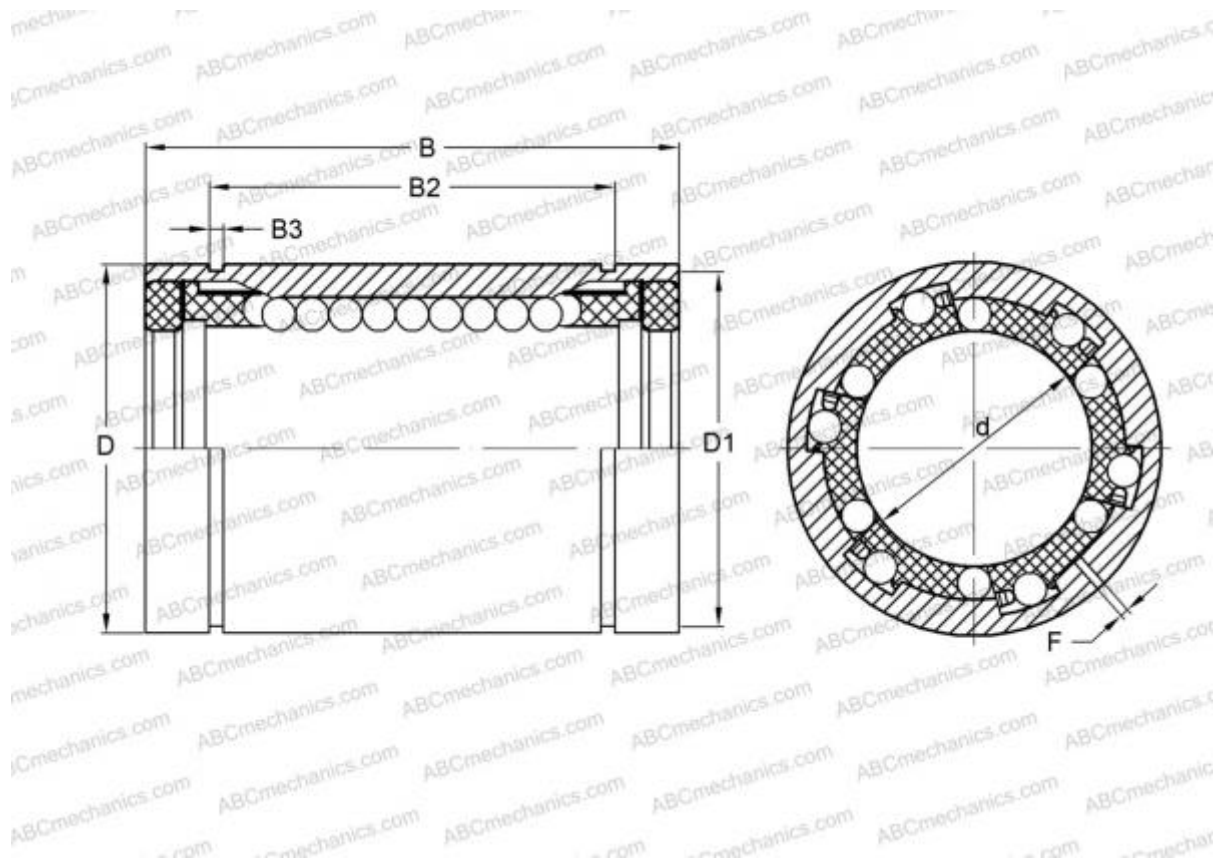

Technical specification

DIMENSIONS, MM

d	25,000
D	40,000
B	58,000
D1	37,500
B2	43,700
B3	1,850
F	1

WEIGHT, KG 0,190

MANUFACTURER [INA](#)

REPLACES

KBS 2558 PP