

KBS30-PP INA

Linear bushing

TYPE: Shaft guidance systems, Linear bushing, Self aligning, Close type, Type KBS..PP, machined range, sealed on both sides (INA)

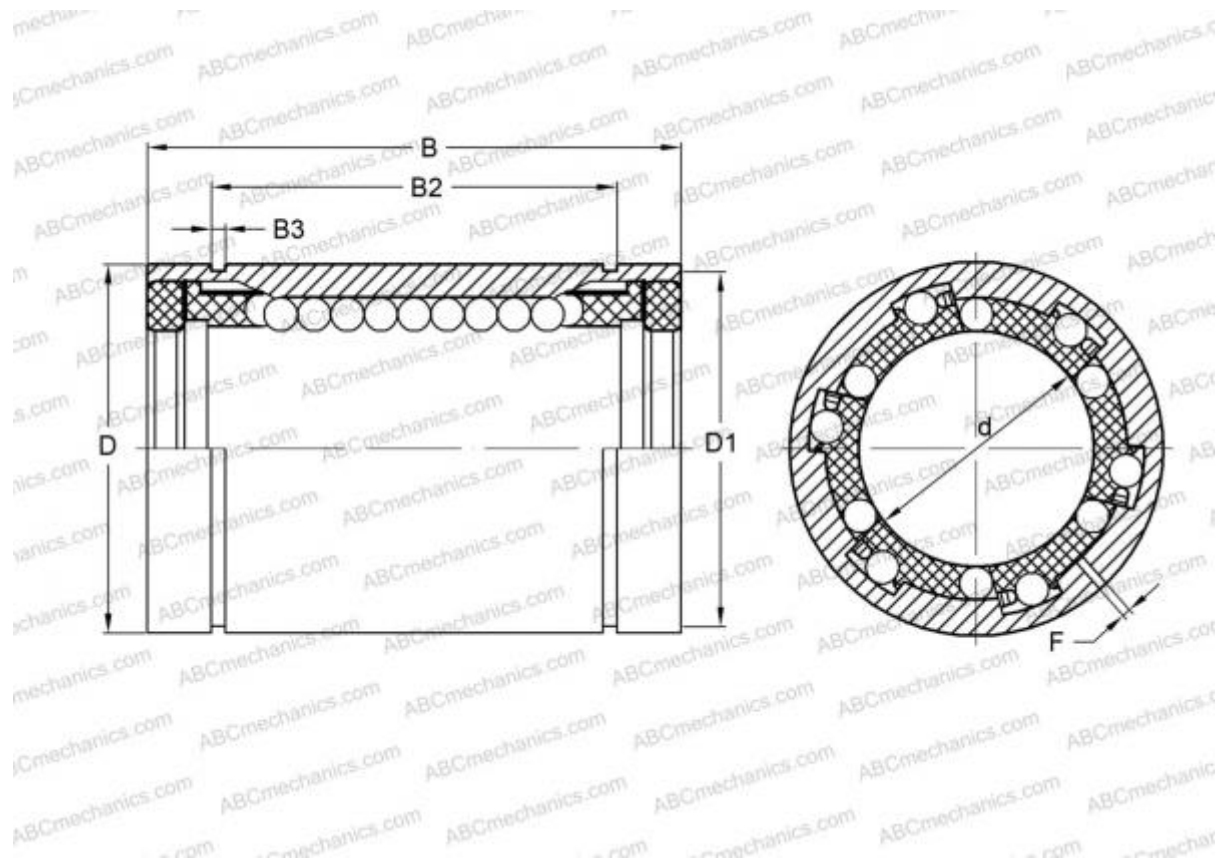

Technical specification

DIMENSIONS, MM

d	30,000
D	47,000
B	68,000
D1	44,500
B2	51,700
B3	1,850
F	1

WEIGHT, KG 0,300

MANUFACTURER [INA](#)

REPLACES

KBS 3068 PP