

SMS 30 NB

Linear bushing

TYPE: Shaft guidance systems, Linear bushing, Standard, Close type, Type SM, Asian standard, Corrosion resistance, Stainless steel cage (NB)

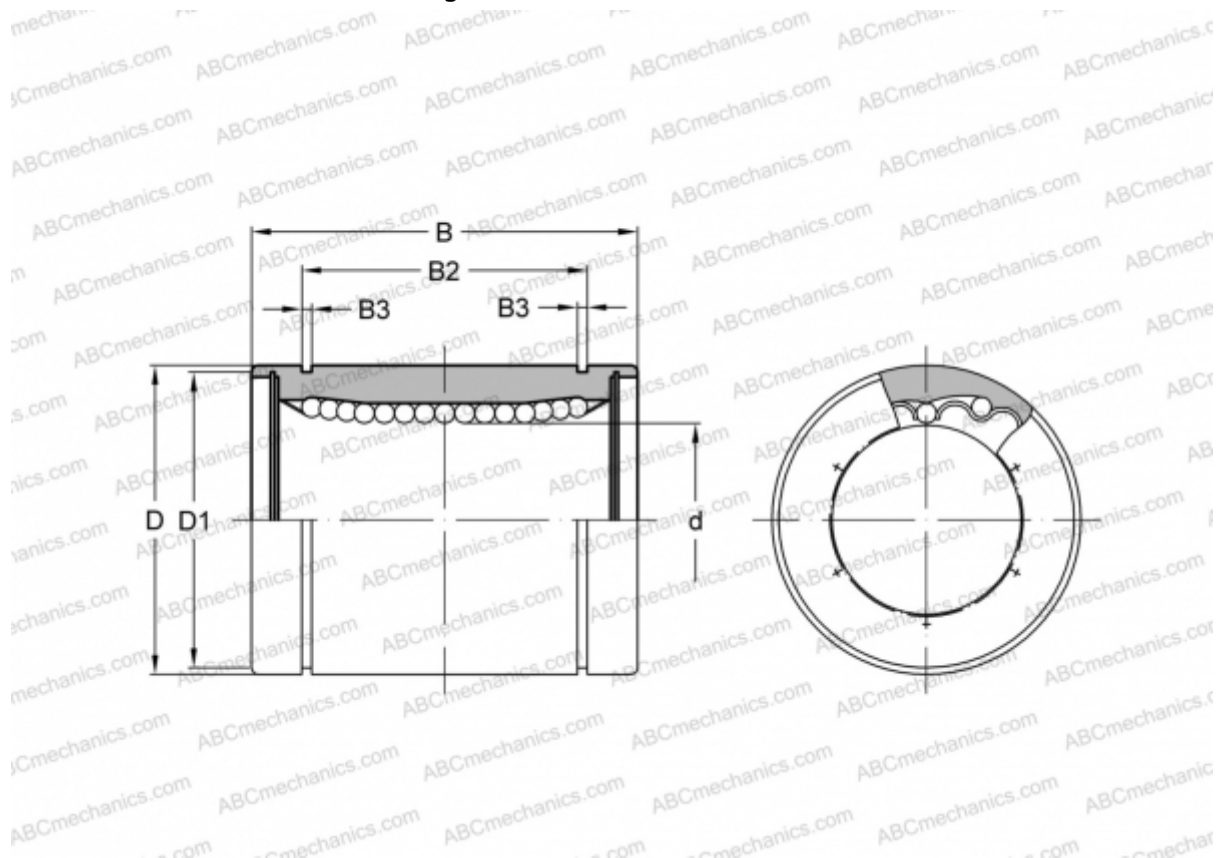

Technical specification

DIMENSIONS, MM

d	30,000
D	45,000
B	64,000
D1	43,000
B2	44,500
B3	1,850

WEIGHT, KG 0,270

MANUFACTURER [NB](#)