

## LBE 12 UU OP ABC

Linear bushing

TYPE: Shaft guidance systems, Linear bushing, Standard, Open type for support rail, Type LBE..UU OP, KBO..PP, LBCT..2LS, sealed on both sides

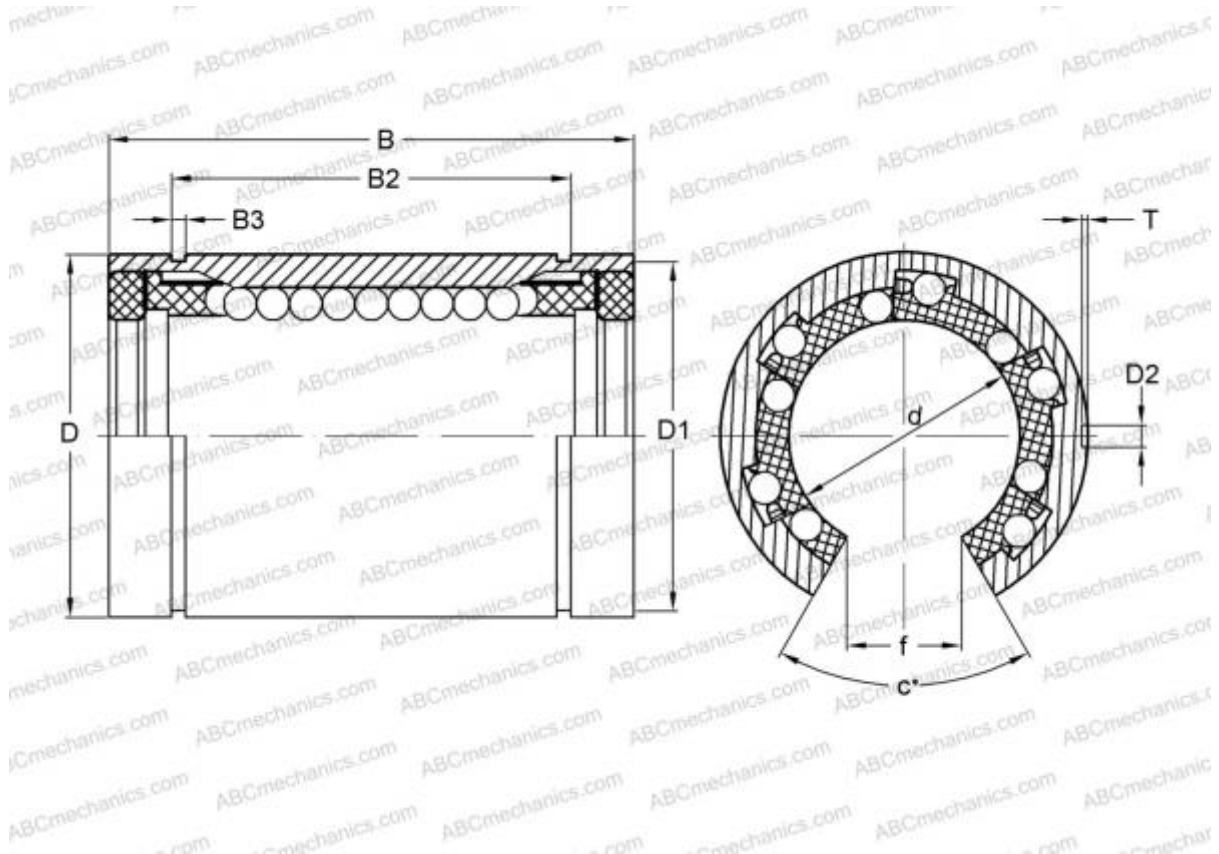

### Technical specification

#### DIMENSIONS, MM

d	12,000
D	22,000
B	32,000
f	7,500
c	78,000

**WEIGHT, KG** 0,030

**MANUFACTURER** [ABC](#)

#### INTERCHANGE

IKO	<a href="#">LBE 12 UU OP</a>
STAR	<a href="#">0632-012-00</a>
THOMSON	<a href="#">0632-012-00</a>
INA	<a href="#">KBO12-PP</a>
SKF	<a href="#">LBCT 12-2LS</a>

#### INTERCHANGE

FAG [LAN 12x22x32.2RS](#)