

0632-012-00 STAR

Linear bushing

TYPE: Shaft guidance systems, Linear bushing, Standard, Open type for support rail, Type LBE..UU OP, KBO..PP, LBCT..2LS, sealed on both sides

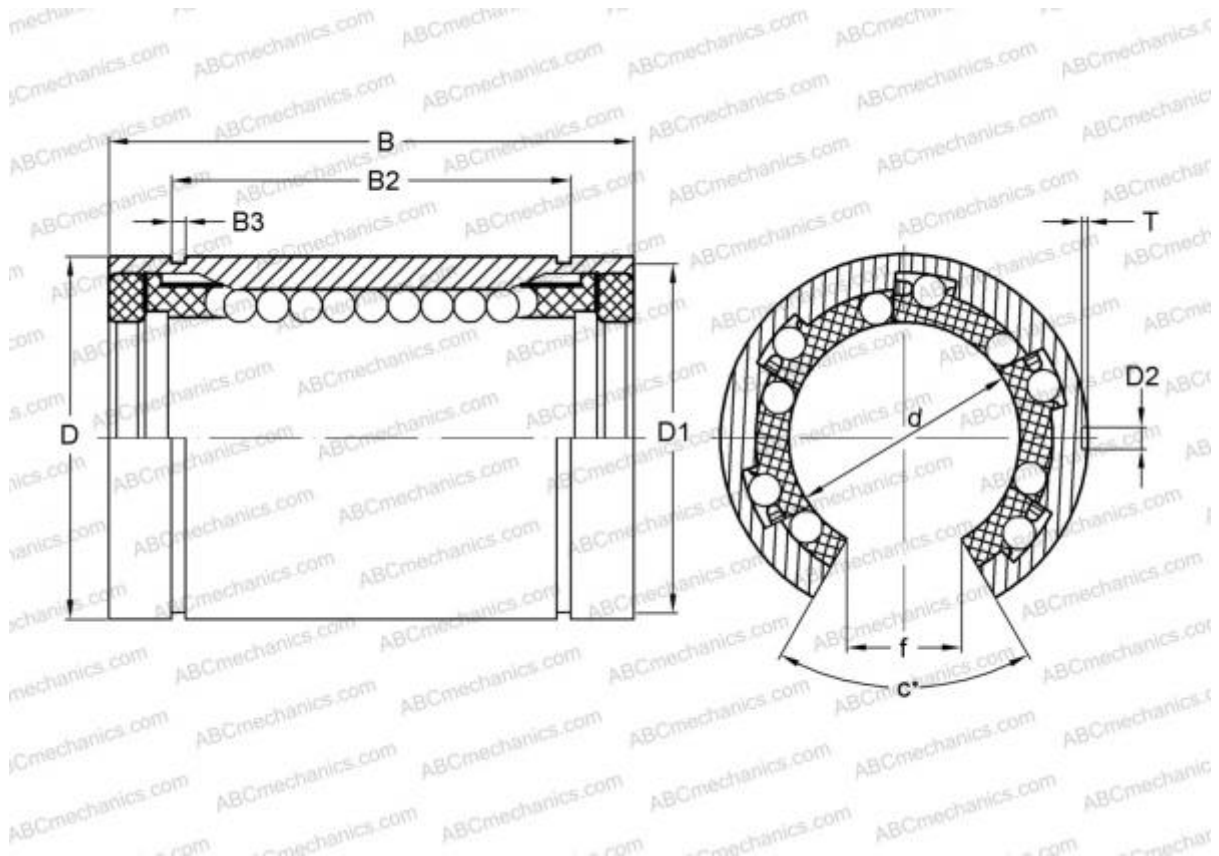

Technical specification

DIMENSIONS, MM

d	12,000
D	22,000
B	32,000
f	7,500
c	78,000

WEIGHT, KG 0,030

MANUFACTURER [STAR](#)

INTERCHANGE

ABC	LBE 12 UU OP
IKO	LBE 12 UU OP
THOMSON	0632-012-00
INA	KBO12-PP
SKF	LBCT 12-2LS

INTERCHANGE

FAG [LAN 12x22x32.2RS](#)