

KBO12-PP INA

Linear bushing

TYPE: Shaft guidance systems, Linear bushing, Standard, Open type for support rail, Type LBE..UU OP, KBO..PP, LBCT..2LS, sealed on both sides

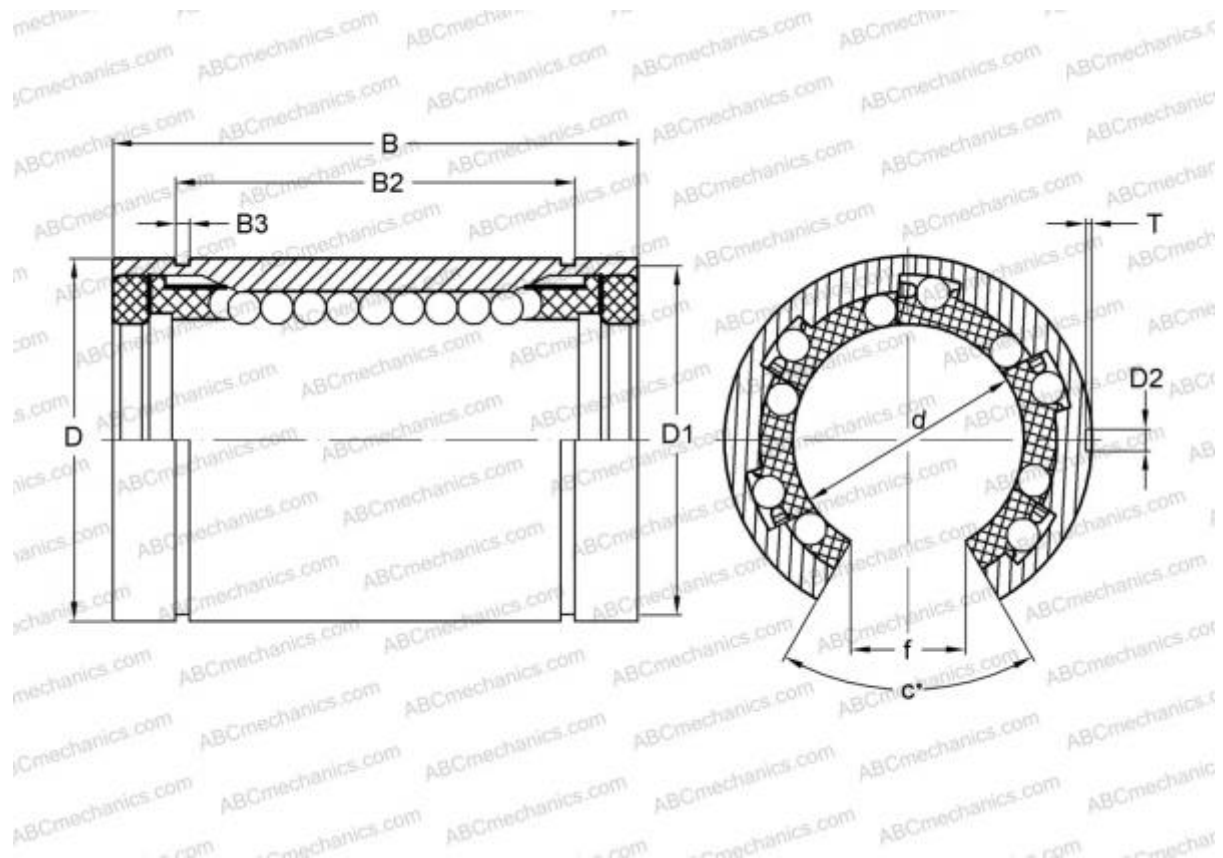

Technical specification

DIMENSIONS, MM

d	12,000
D	22,000
B	32,000
D1	21,000
D2	2,200
B2	22,600
B3	1,300
T	1,200
f	7,700
c	78,000

WEIGHT, KG 0,030

MANUFACTURER [INA](#)

INTERCHANGE

ABC	LBE 12 UU OP
IKO	LBE 12 UU OP
STAR	0632-012-00
THOMSON	0632-012-00
SKF	LBCT 12-2LS
FAG	LAN 12x22x32.2RS

REPLACES

KBO 1232 PP