

## LBCT 20-2LS SKF

Linear bushing

TYPE: Shaft guidance systems, Linear bushing, Standard, Open type for support rail, Type LBE..UU OP, KBO..PP, LBCT..2LS, sealed on both sides

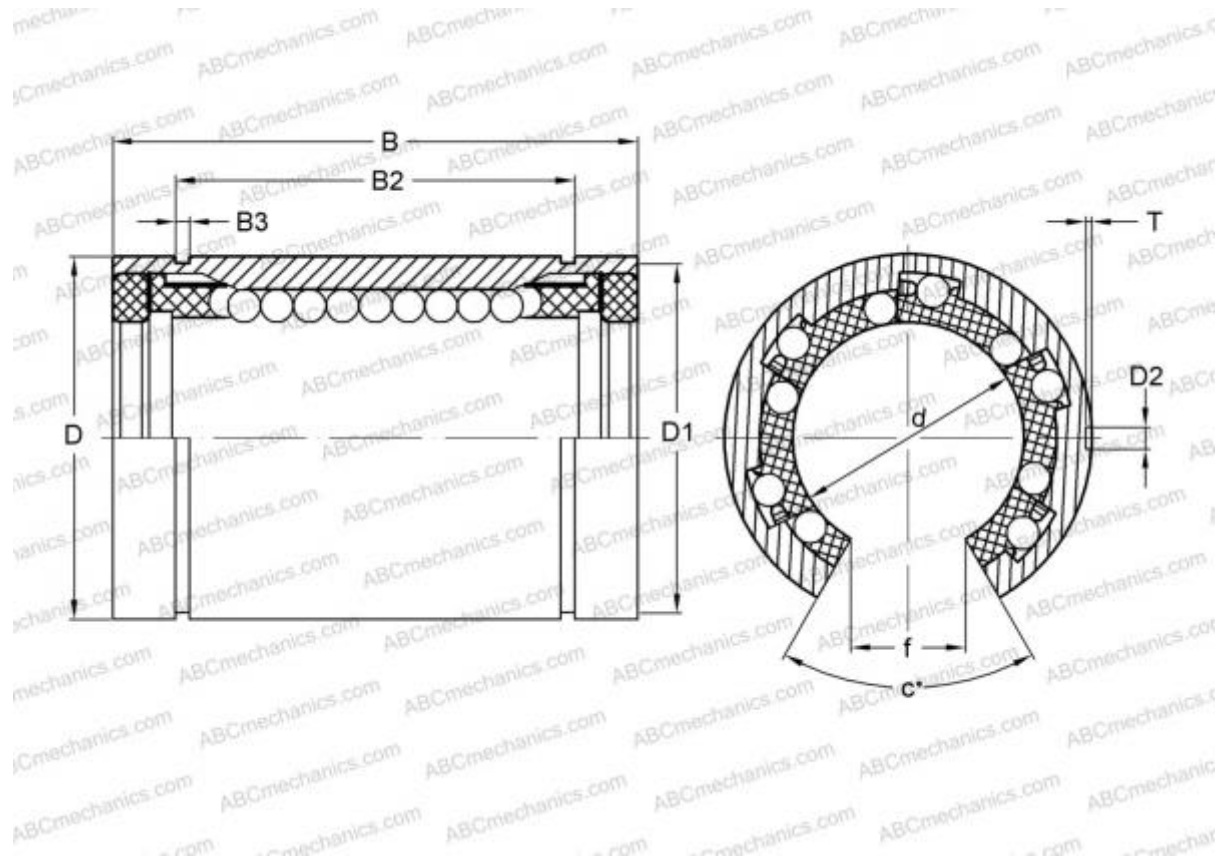

### Technical specification

#### DIMENSIONS, MM

d	20,000
D	32,000
B	45,000
f	10,000
c	60,000

**WEIGHT, KG** 0,073

**MANUFACTURER** [SKF](#)

#### INTERCHANGE

ABC	<a href="#">LBE 20 UU OP</a>
IKO	<a href="#">LBE 20 UU OP</a>
STAR	<a href="#">0632-020-00</a>
THOMSON	<a href="#">0632-020-00</a>
INA	<a href="#">KBO20-PP</a>

#### INTERCHANGE

FAG [LAN 20x32x45.2RS](#)