

LAN 20x32x45.2RS FAG

Linear bushing

TYPE: Shaft guidance systems, Linear bushing, Standard, Open type for support rail, Type LBE..UU OP, KBO..PP, LBCT..2LS, sealed on both sides

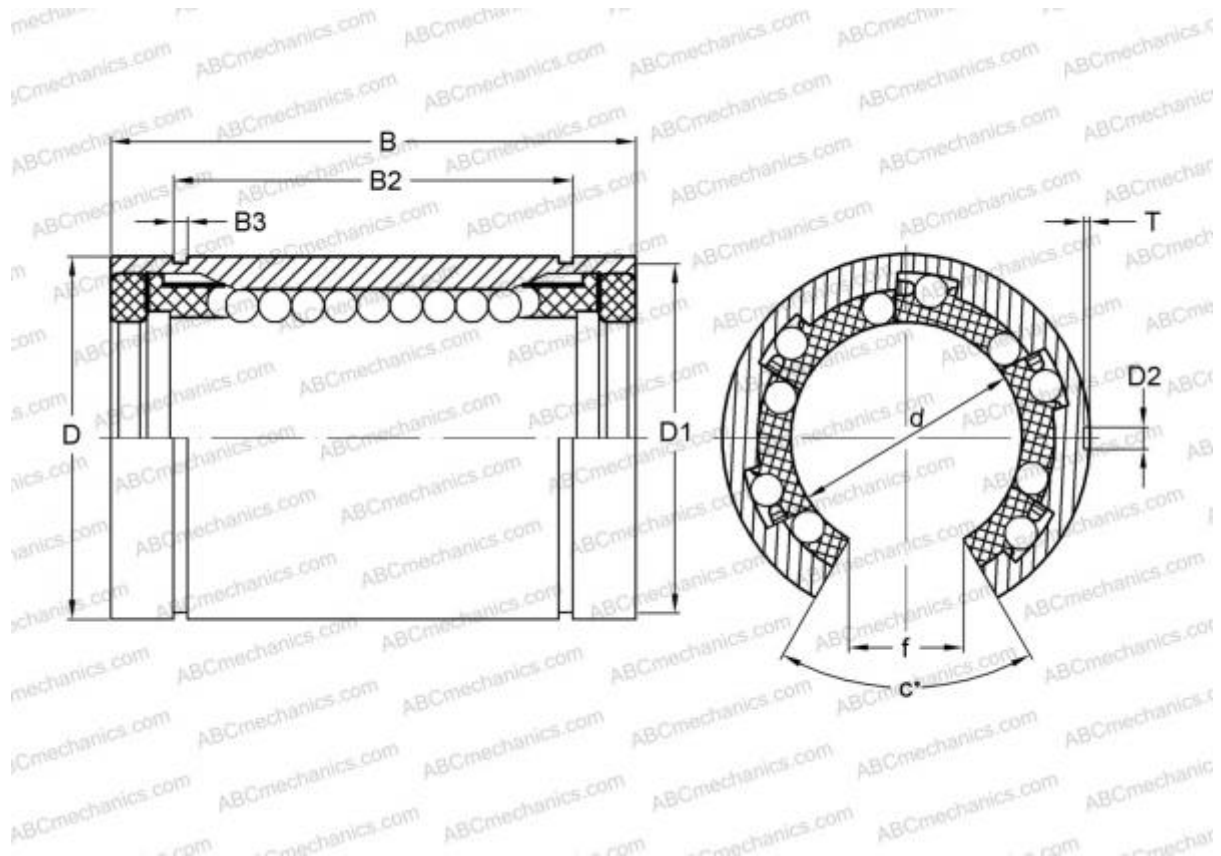

Technical specification

DIMENSIONS, MM

d	20,000
D	32,000
B	45,000
f	10,000
c	60,000

WEIGHT, KG 0,073

MANUFACTURER [FAG](#)

INTERCHANGE

ABC	LBE 20 UU OP
IKO	LBE 20 UU OP
STAR	0632-020-00
THOMSON	0632-020-00
INA	KBO20-PP

INTERCHANGE

SKF [LBCT 20-2LS](#)