

LBE 25 UU OP IKO

Linear bushing

TYPE: Shaft guidance systems, Linear bushing, Standard, Open type for support rail, Type LBE..UU OP, KBO..PP, LBCT..2LS, sealed on both sides

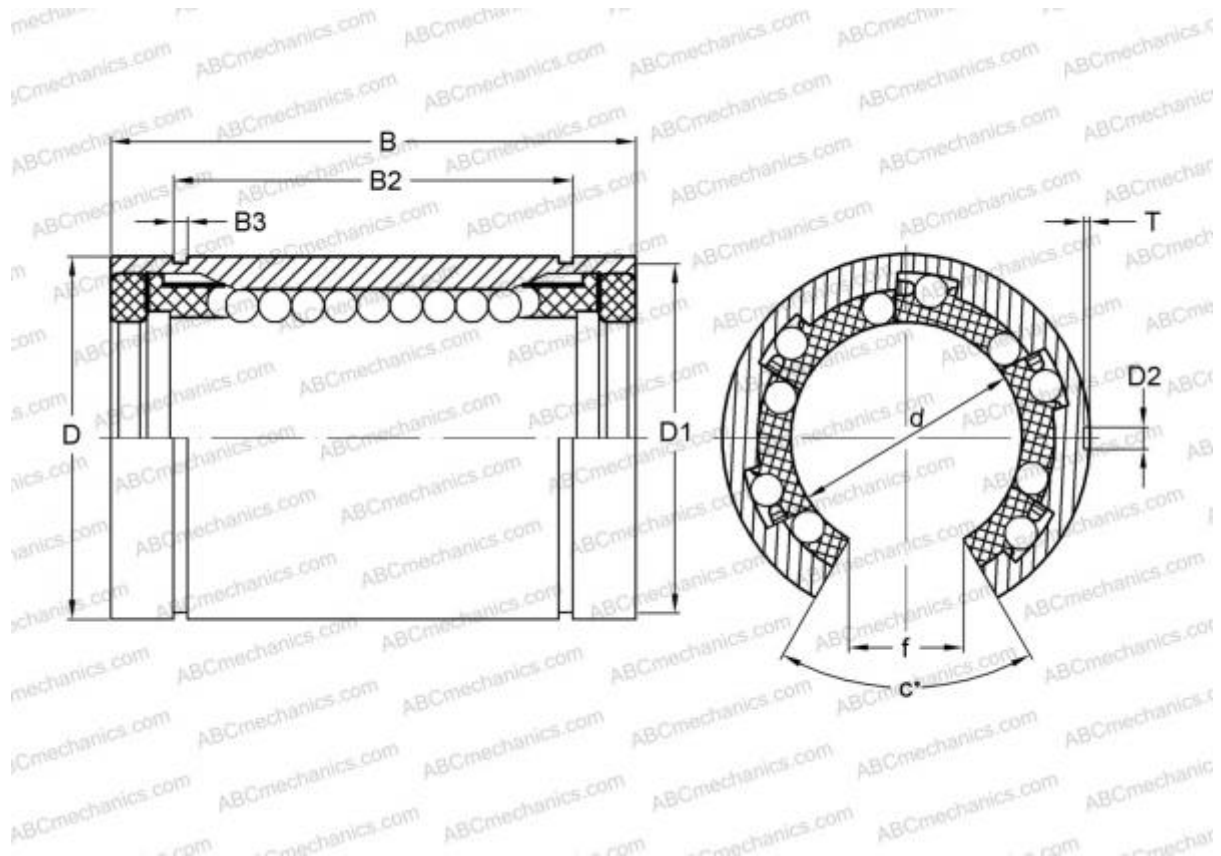

Technical specification

DIMENSIONS, MM

d	25,000
D	40,000
B	58,000
f	12,500
c	60,000

WEIGHT, KG 0,142

MANUFACTURER [IKO](#)

INTERCHANGE

ABC	LBE 25 UU OP
STAR	0632-025-00
THOMSON	0632-025-00
INA	KBO25-PP
SKF	LBCT 25-2LS

INTERCHANGE

FAG [LAN 25x40x58.2RS](#)

CALCULATION DATA

Basic dynamic load rating min	1,070 kN
Basic dynamic load rating max	1,270 kN
Basic static load rating min	2,020 kN
Basic static load rating max	2,960 kN