

## LBCT 25-2LS SKF

Linear bushing

TYPE: Shaft guidance systems, Linear bushing, Standard, Open type for support rail, Type LBE..UU OP, KBO..PP, LBCT..2LS, sealed on both sides

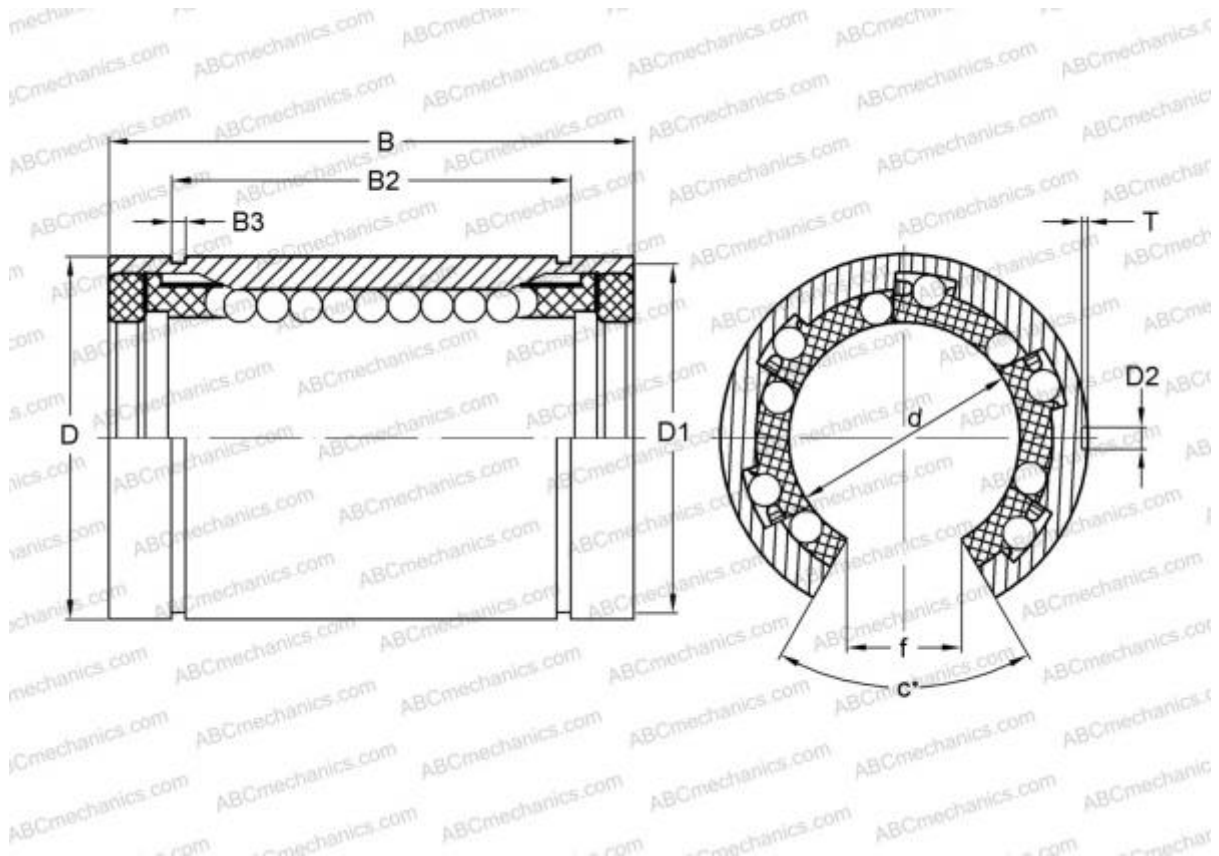

### Technical specification

#### DIMENSIONS, MM

d	25,000
D	40,000
B	58,000
f	12,500
c	60,000

**WEIGHT, KG** 0,142

**MANUFACTURER** [SKF](#)

#### INTERCHANGE

ABC	<a href="#">LBE 25 UU OP</a>
IKO	<a href="#">LBE 25 UU OP</a>
STAR	<a href="#">0632-025-00</a>
THOMSON	<a href="#">0632-025-00</a>
INA	<a href="#">KBO25-PP</a>

#### INTERCHANGE

FAG [LAN 25x40x58.2RS](#)