

LAN 25x40x58.2RS FAG

Linear bushing

TYPE: Shaft guidance systems, Linear bushing, Standard, Open type for support rail, Type LBE..UU OP, KBO..PP, LBCT..2LS, sealed on both sides

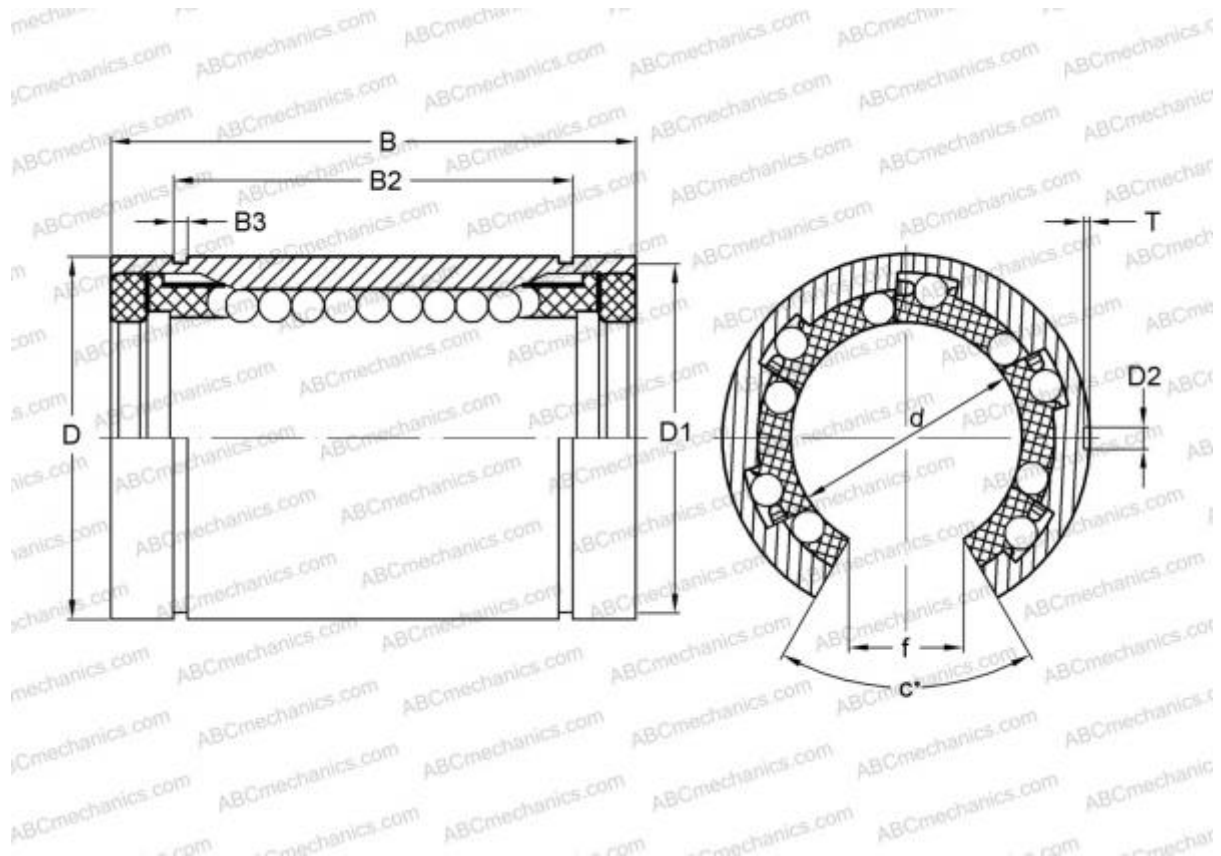

Technical specification

DIMENSIONS, MM

d	25,000
D	40,000
B	58,000
f	12,500
c	60,000

WEIGHT, KG 0,142

MANUFACTURER [FAG](#)

INTERCHANGE

ABC	LBE 25 UU OP
IKO	LBE 25 UU OP
STAR	0632-025-00
THOMSON	0632-025-00
INA	KBO25-PP

INTERCHANGE

SKF [LBCT 25-2LS](#)