

0632-030-00 THOMSON

Linear bushing

TYPE: Shaft guidance systems, Linear bushing, Standard, Open type for support rail, Type LBE..UU OP, KBO..PP, LBCT..2LS, sealed on both sides

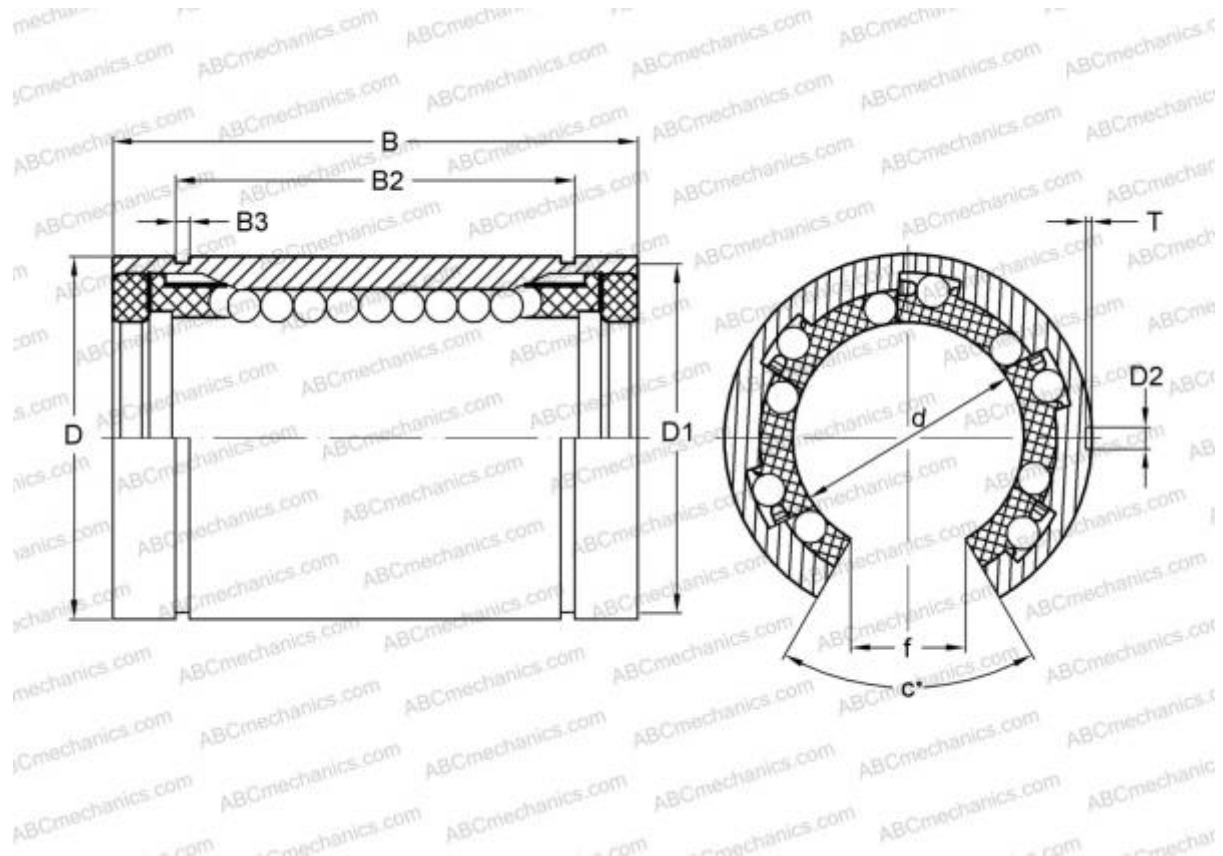

Technical specification

DIMENSIONS, MM

d	30,000
D	47,000
B	68,000
f	12,500
c	50,000

WEIGHT, KG 0,265

MANUFACTURER [THOMSON](#)

INTERCHANGE

ABC	LBE 30 UU OP
IKO	LBE 30 UU OP
STAR	0632-030-00
INA	KBO30-PP
SKF	LBCT 30-2LS

INTERCHANGE

FAG [LAN 30x47x68.2RS](#)