

## KBO30-PP INA

Linear bushing

TYPE: Shaft guidance systems, Linear bushing, Standard, Open type for support rail, Type LBE..UU OP, KBO..PP, LBCT..2LS, sealed on both sides

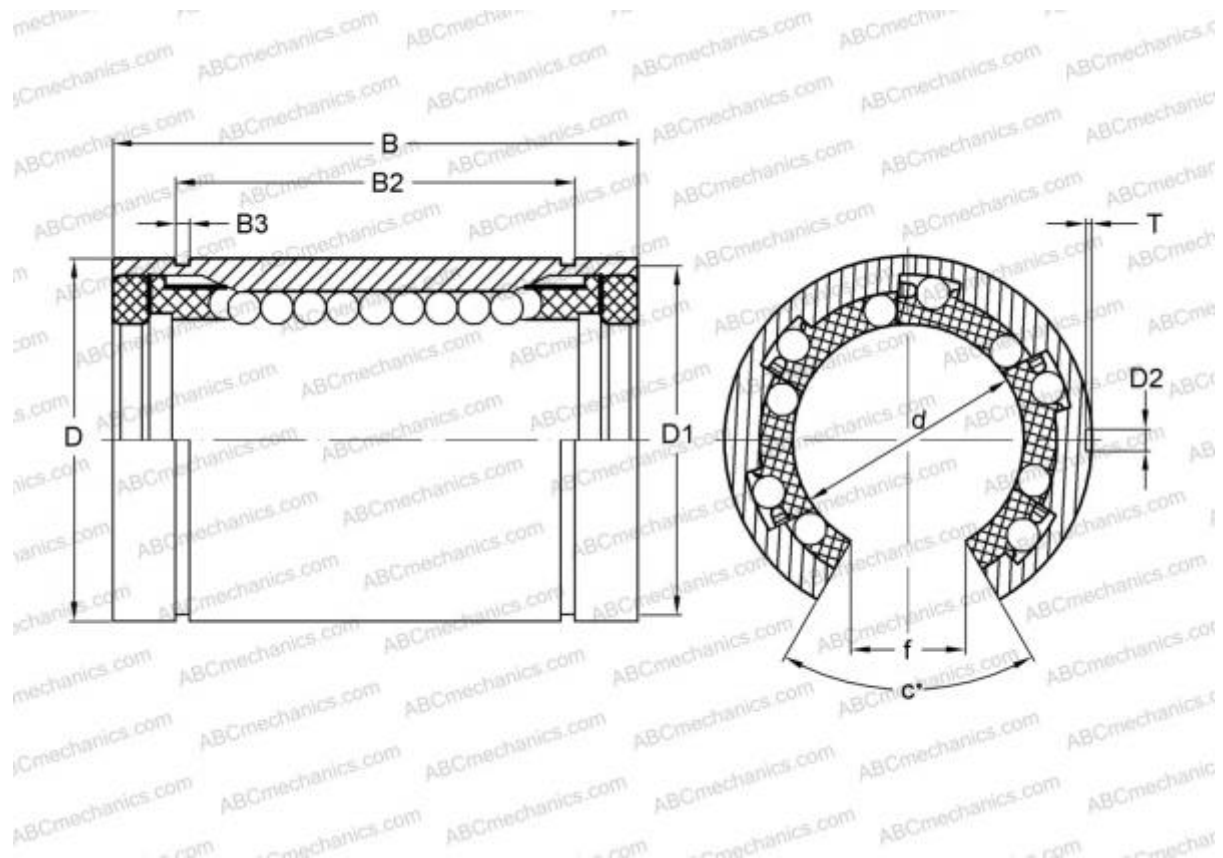

### Technical specification

#### DIMENSIONS, MM

d	30,000
D	47,000
B	68,000
D1	44,500
D2	3,000
B2	51,700
B3	1,850
T	1,500
f	13,600
c	54,000

**WEIGHT, KG** 0,240

**MANUFACTURER** [INA](http://www.ina.com)

#### INTERCHANGE

ABC	<a href="#">LBE 30 UU OP</a>
IKO	<a href="#">LBE 30 UU OP</a>
STAR	<a href="#">0632-030-00</a>
THOMSON	<a href="#">0632-030-00</a>
SKF	<a href="#">LBCT 30-2LS</a>
FAG	<a href="#">LAN 30x47x68.2RS</a>

#### REPLACES

KBO 3068 PP