

LBE 40 UU OP IKO

Linear bushing

TYPE: Shaft guidance systems, Linear bushing, Standard, Open type for support rail, Type LBE..UU OP, KBO..PP, LBCT..2LS, sealed on both sides

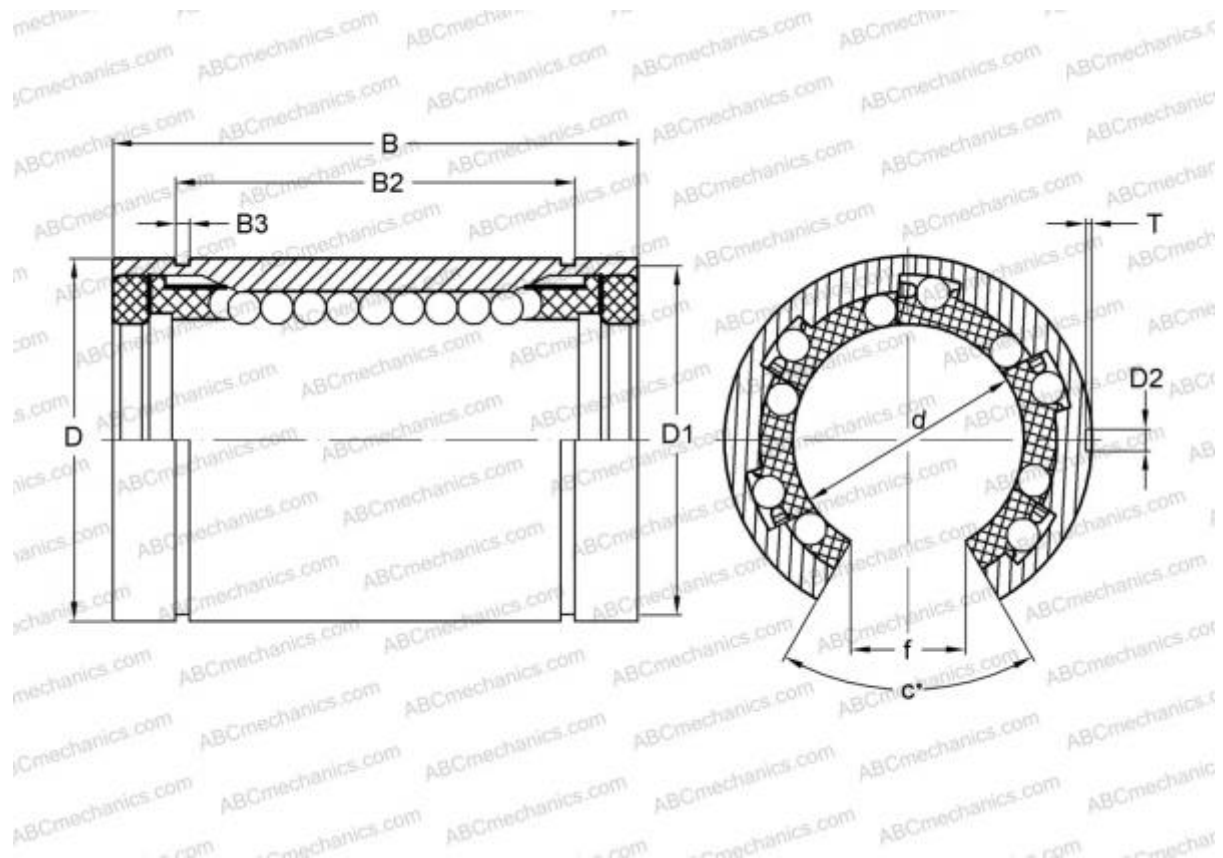

Technical specification

DIMENSIONS, MM

d	40,000
D	62,000
B	80,000
f	16,800
c	50,000

WEIGHT 0,485

MANUFACTURER [IKO](#)

INTERCHANGE

ABC	LBE 40 UU OP
STAR	0632-040-00
THOMSON	0632-040-00
INA	KBO40-PP
SKF	LBCT 40-2LS

INTERCHANGE

FAG [LAN 40x62x80.2RS](#)

CALCULATION DATA

Basic dynamic load rating min	2,710 kN
Basic dynamic load rating max	2,870 kN
Basic static load rating min	4,890 kN
Basic static load rating max	6,250 kN