

0632-040-00 STAR

Linear bushing

TYPE: Shaft guidance systems, Linear bushing, Standard, Open type for support rail, Type LBE..UU OP, KBO..PP, LBCT..2LS, sealed on both sides

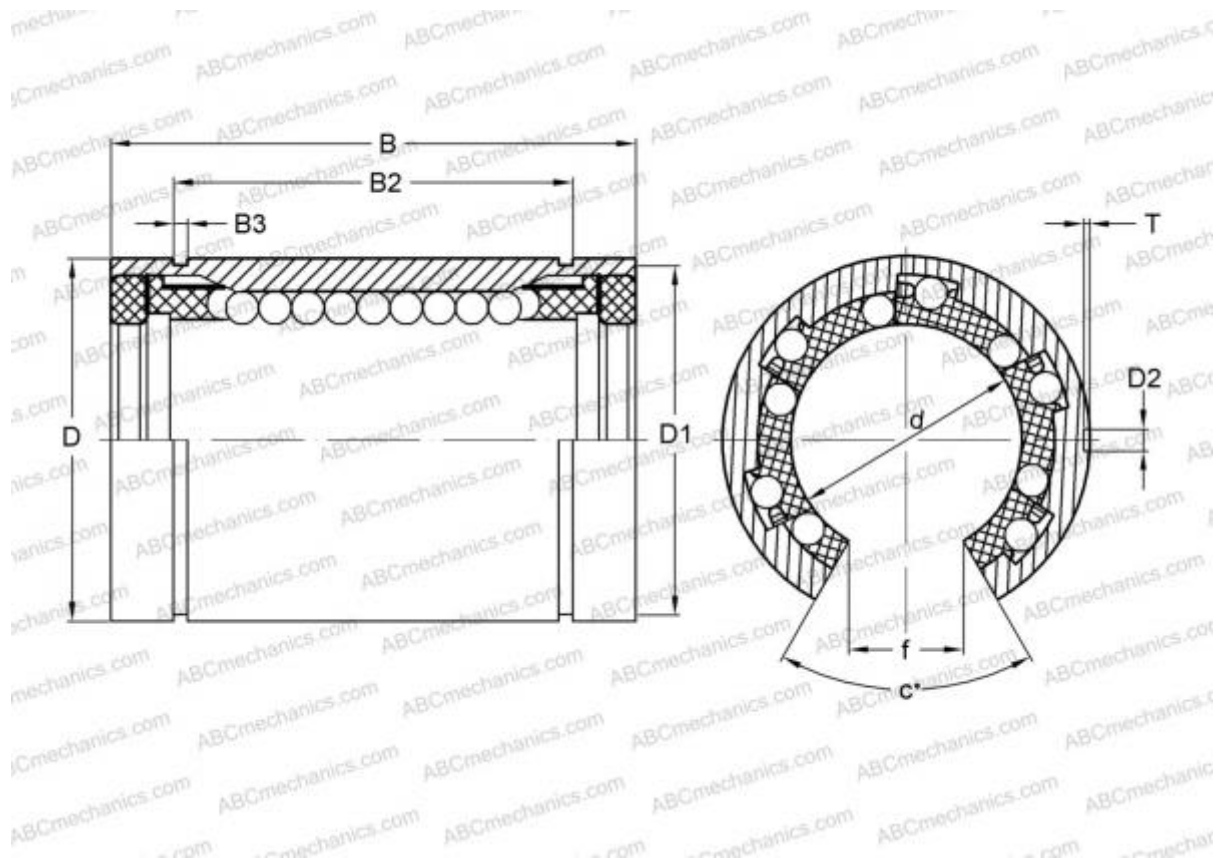

Technical specification

DIMENSIONS, MM

d	40,000
D	62,000
B	80,000
f	16,800
c	50,000

WEIGHT 0,485

MANUFACTURER [STAR](#)

INTERCHANGE

ABC	LBE 40 UU OP
IKO	LBE 40 UU OP
THOMSON	0632-040-00
INA	KBO40-PP
SKF	LBCT 40-2LS

INTERCHANGE

FAG [LAN 40x62x80.2RS](#)