

LBB 4 IKO

Linear bushing

TYPE: Shaft guidance systems, Linear bushing, Standard, Close type, Type LBB, inch

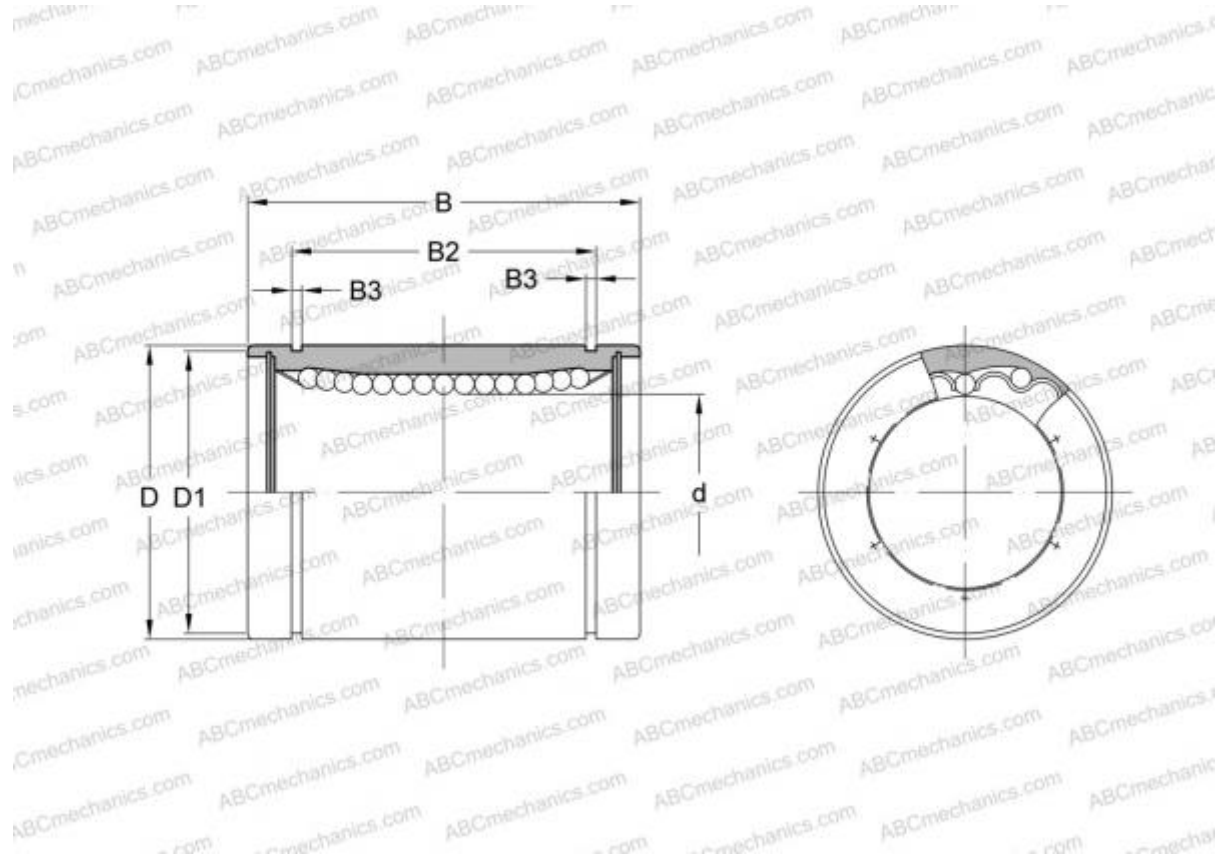

Technical specification

DIMENSIONS, MM

d	6,350
D	12,700
B	19,050

WEIGHT, KG 0,007

MANUFACTURER [IKO](#)

INTERCHANGE

ABC	LBB 4
THOMSON	A-4812
HEIM	LBB-250

CALCULATION DATA

Basic static load rating max	0,156 kN
------------------------------	----------

CALCULATION DATA

Basic dynamic load rating min	0,080 kN
Basic dynamic load rating max	0,065 kN
Basic static load rating min	0,156 kN