

LBB 6 IKO

Linear bushing

TYPE: Shaft guidance systems, Linear bushing, Standard, Close type, Type LBB, inch

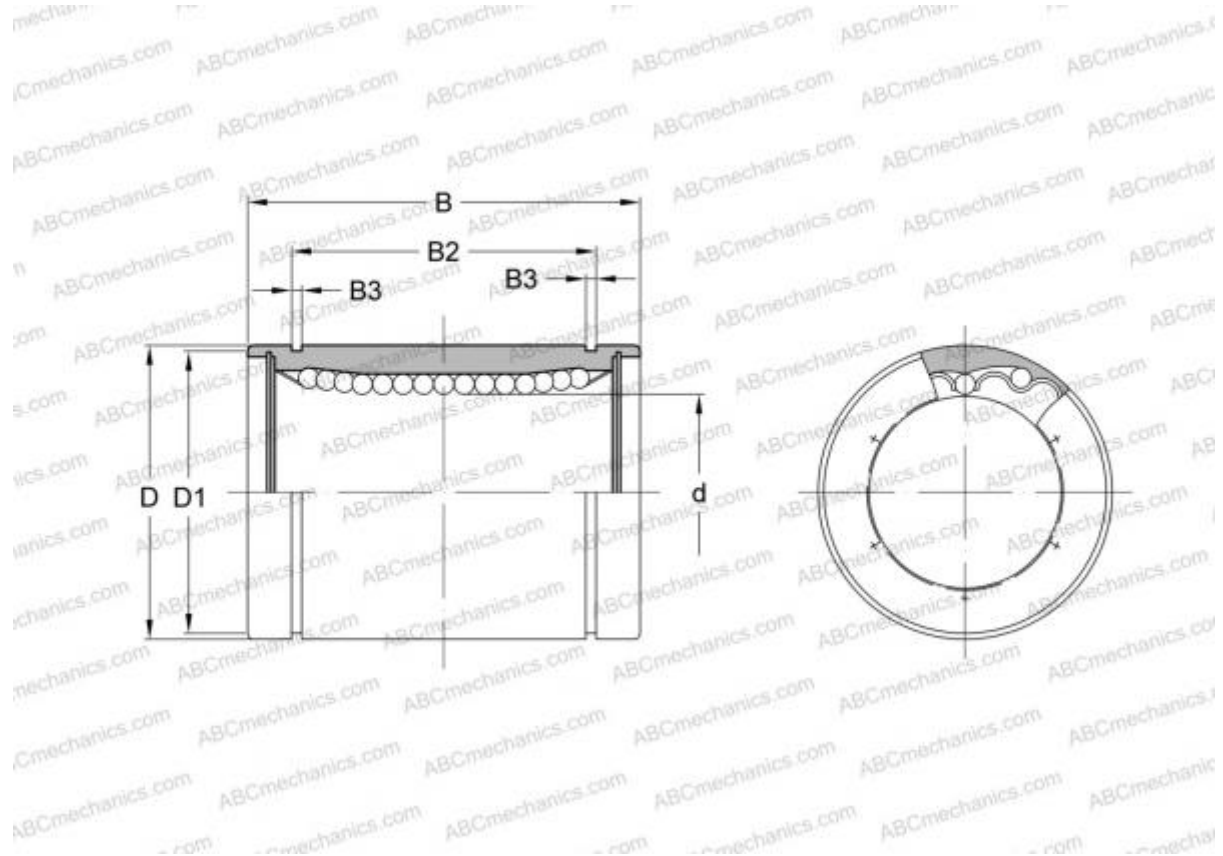

Technical specification

DIMENSIONS, MM

d	9,525
D	15,875
B	22,225

WEIGHT, KG 0,010

MANUFACTURER [IKO](#)

INTERCHANGE

ABC	LBB 6
THOMSON	A-61014
HEIM	LBB-375

CALCULATION DATA

Basic dynamic load rating min	0,117 kN
Basic dynamic load rating max	0,134 kN
Basic static load rating min	0,227 kN

CALCULATION DATA

Basic static load rating max	0,320 kN
------------------------------	----------