

LBB 10 IKO

Linear bushing

TYPE: Shaft guidance systems, Linear bushing, Standard, Close type, Type LBB, inch

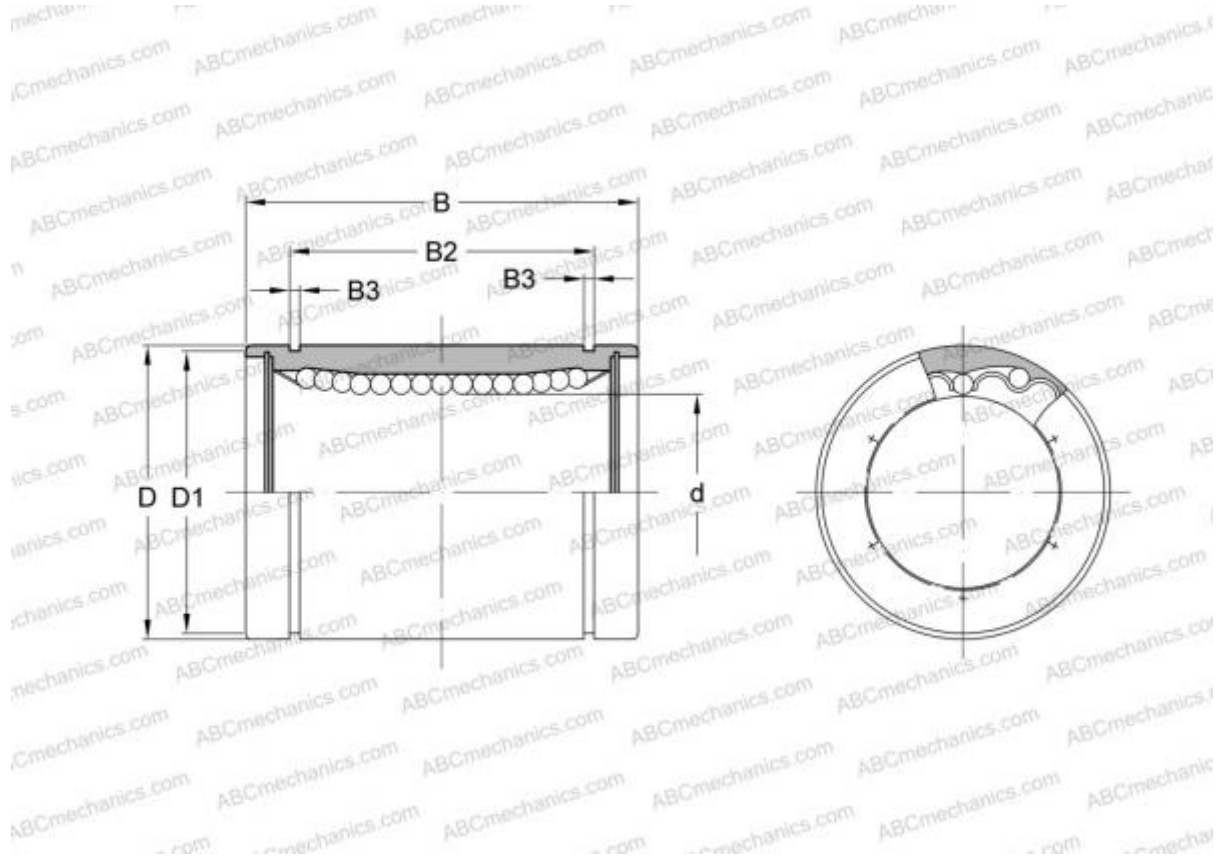

Technical specification

DIMENSIONS, MM

d	15,875
D	28,575
B	38,100

WEIGHT, KG 0,065

MANUFACTURER [IKO](#)

INTERCHANGE

ABC	LBB 10
THOMSON	A-101824
HEIM	LBB-625

CALCULATION DATA

Basic static load rating max	1,080 kN
------------------------------	----------

CALCULATION DATA

Basic dynamic load rating min	0,424 kN
Basic dynamic load rating max	0,488 kN
Basic static load rating min	0,766 kN