

## A-101824 THOMSON

Linear bushing

TYPE: Shaft guidance systems, Linear bushing, Standard, Close type, Type LBB, inch

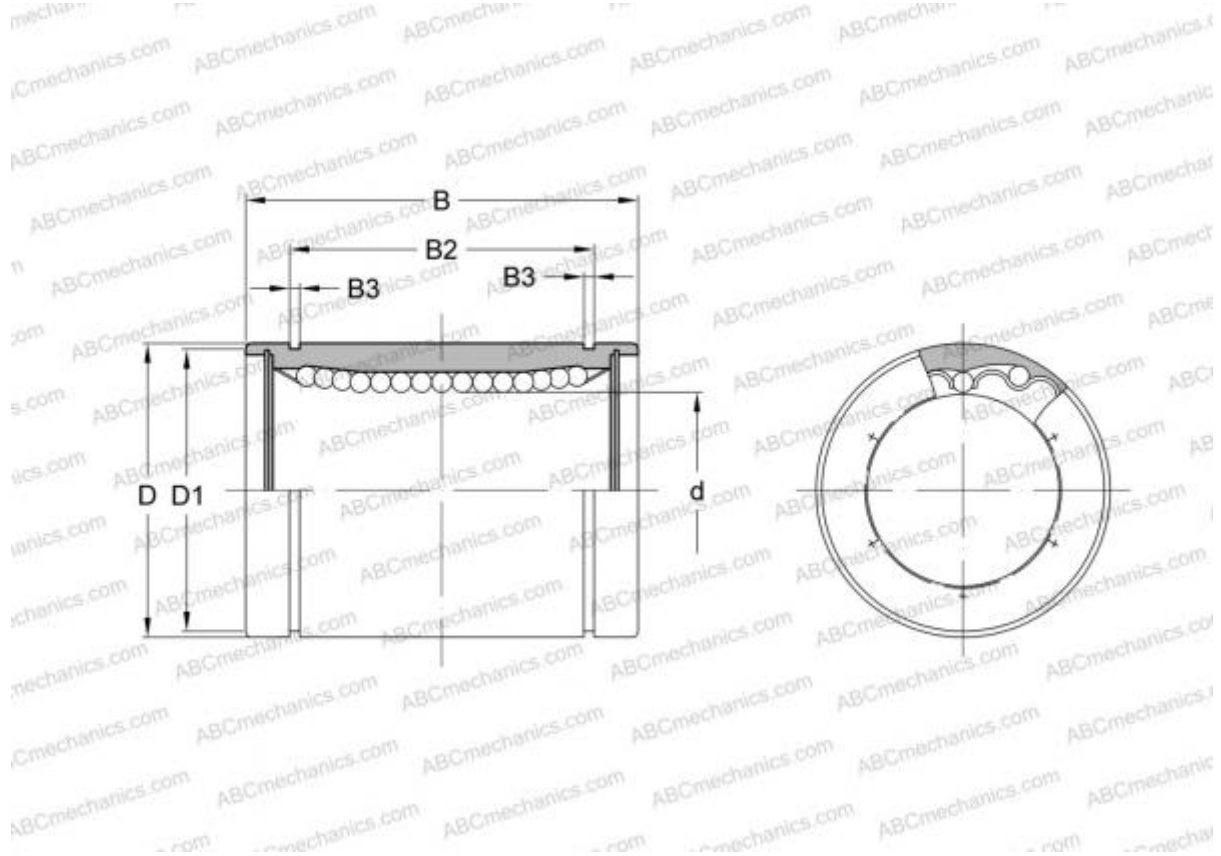

### Technical specification

#### DIMENSIONS, MM

d	15,875
D	28,575
B	38,100

**WEIGHT, KG** 0,065

**MANUFACTURER** [THOMSON](#)

#### INTERCHANGE

ABC	<a href="#">LBB 10</a>
IKO	<a href="#">LBB 10</a>
HEIM	<a href="#">LBB-625</a>