

LBB-1500 HEIM

Linear bushing

TYPE: Shaft guidance systems, Linear bushing, Standard, Close type, Type LBB, inch

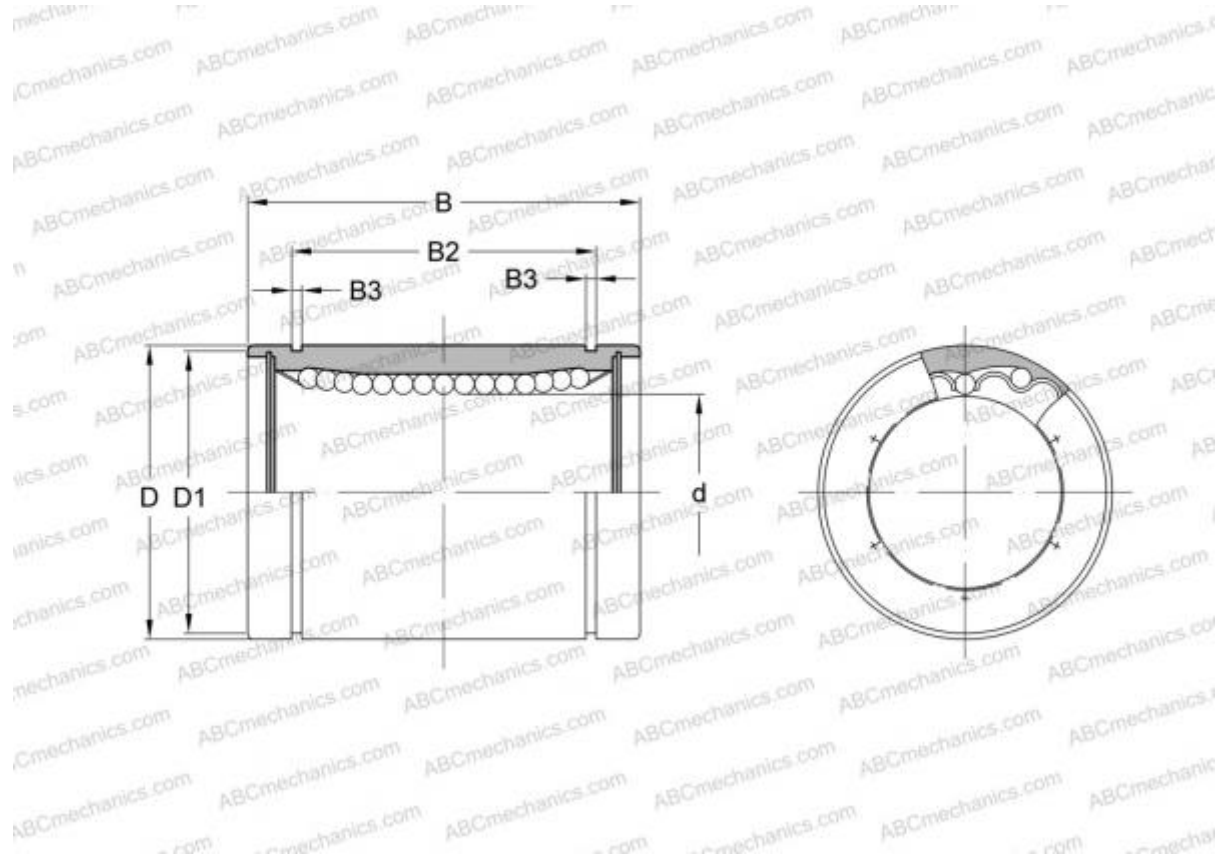

Technical specification

DIMENSIONS, MM

d	38,100
D	60,325
B	76,200

WEIGHT, KG 0,535

MANUFACTURER [HEIM](#)

INTERCHANGE

ABC	LBB 24
IKO	LBB 24
THOMSON	A-243848