

SMS 6G NB

Linear bushing

TYPE: Shaft guidance systems, Linear bushing, Standard, Close type, Type SM, Asian standard, Corrosion resistance, Plastic cage (NB)

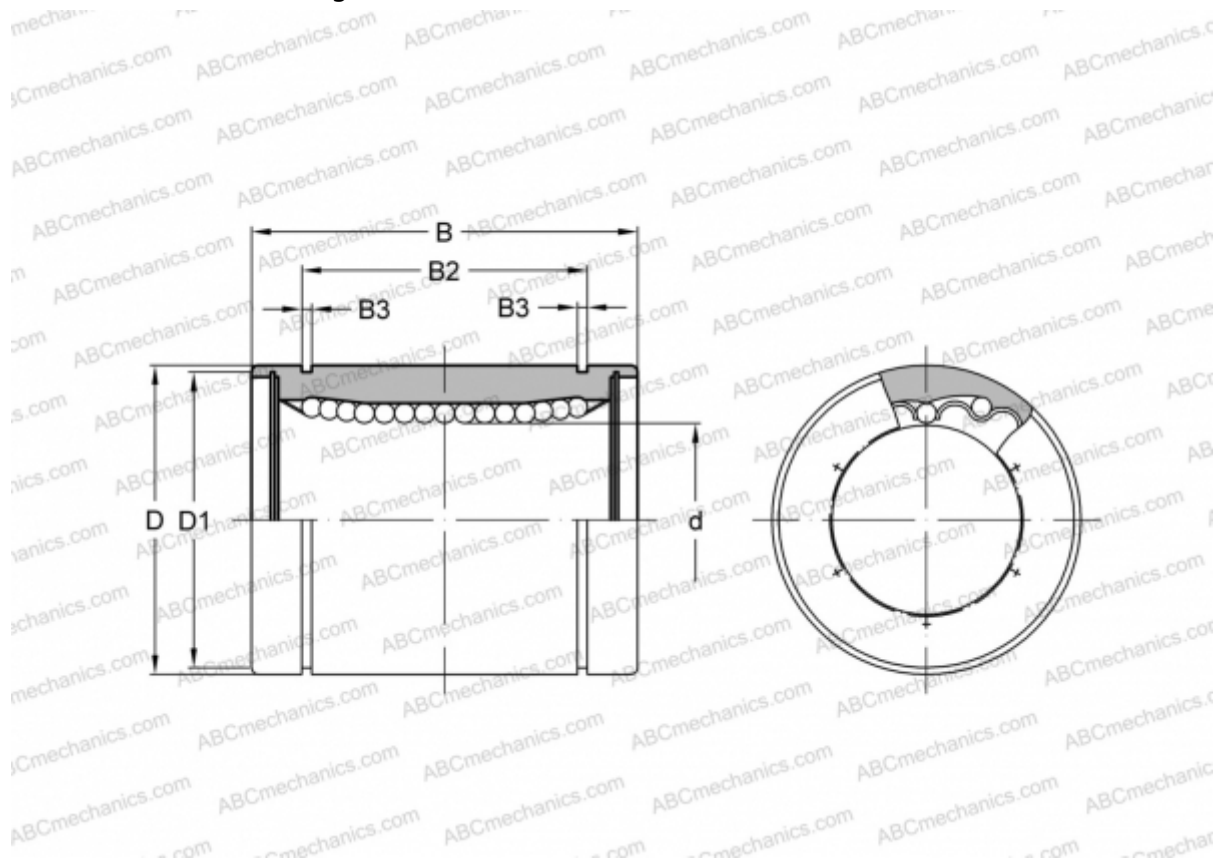

Technical specification

DIMENSIONS, MM

d	6,000
D	12,000
B	19,000
D1	11,500
B2	13,500
B3	1,100

WEIGHT, KG 0,009

MANUFACTURER [NB](#)