

## ADJ-625 HEIM

Linear bushing

TYPE: Shaft guidance systems, Linear bushing, Standard, Adjustable type, Type LBB..AJ, inch

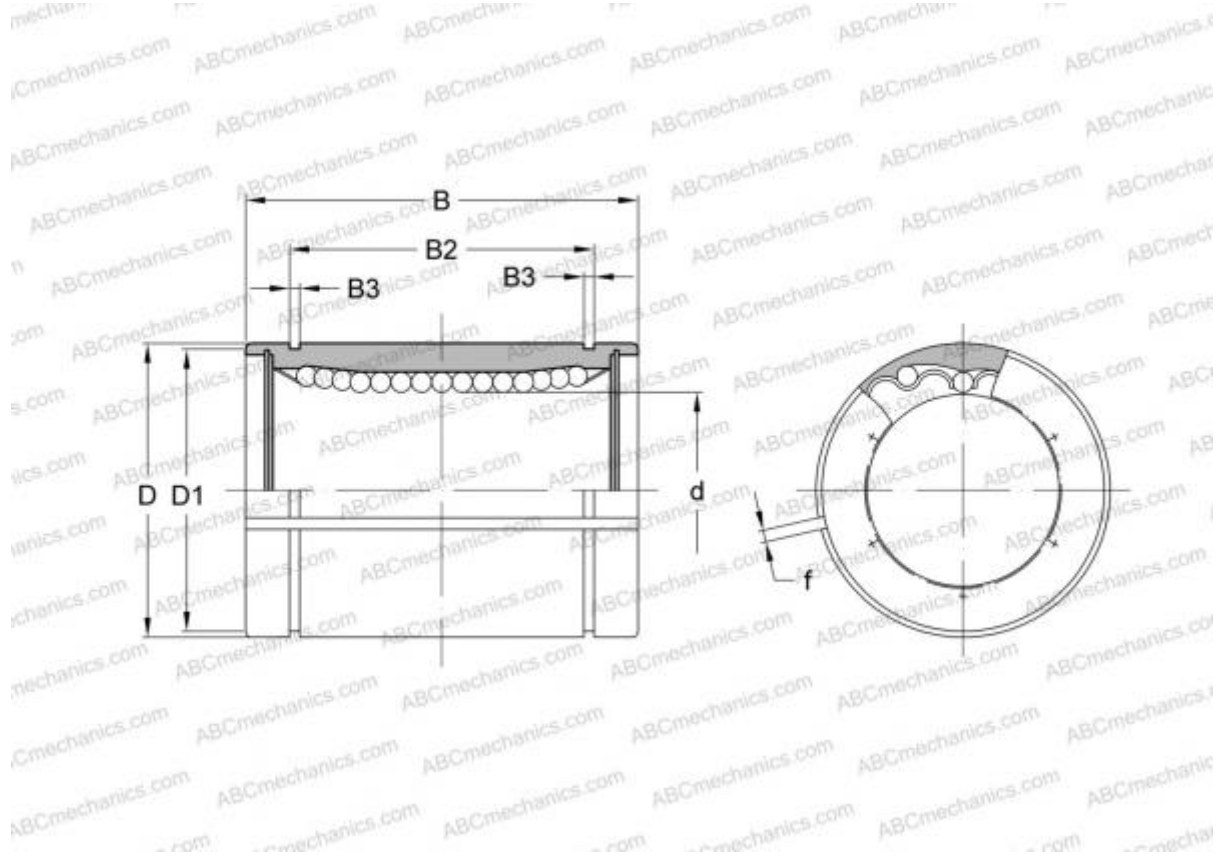

### Technical specification

#### DIMENSIONS, MM

d	15,875
D	28,575
B	38,100
f	2,381

**WEIGHT, KG** 0,064

**MANUFACTURER** [HEIM](#)

#### INTERCHANGE

ABC	<a href="#">LBB 10 AJ</a>
IKO	<a href="#">LBB 10 AJ</a>
THOMSON	<a href="#">ADJ-101824</a>