

ADJ-750 HEIM

Linear bushing

TYPE: Shaft guidance systems, Linear bushing, Standard, Adjustable type, Type LBB..AJ, inch

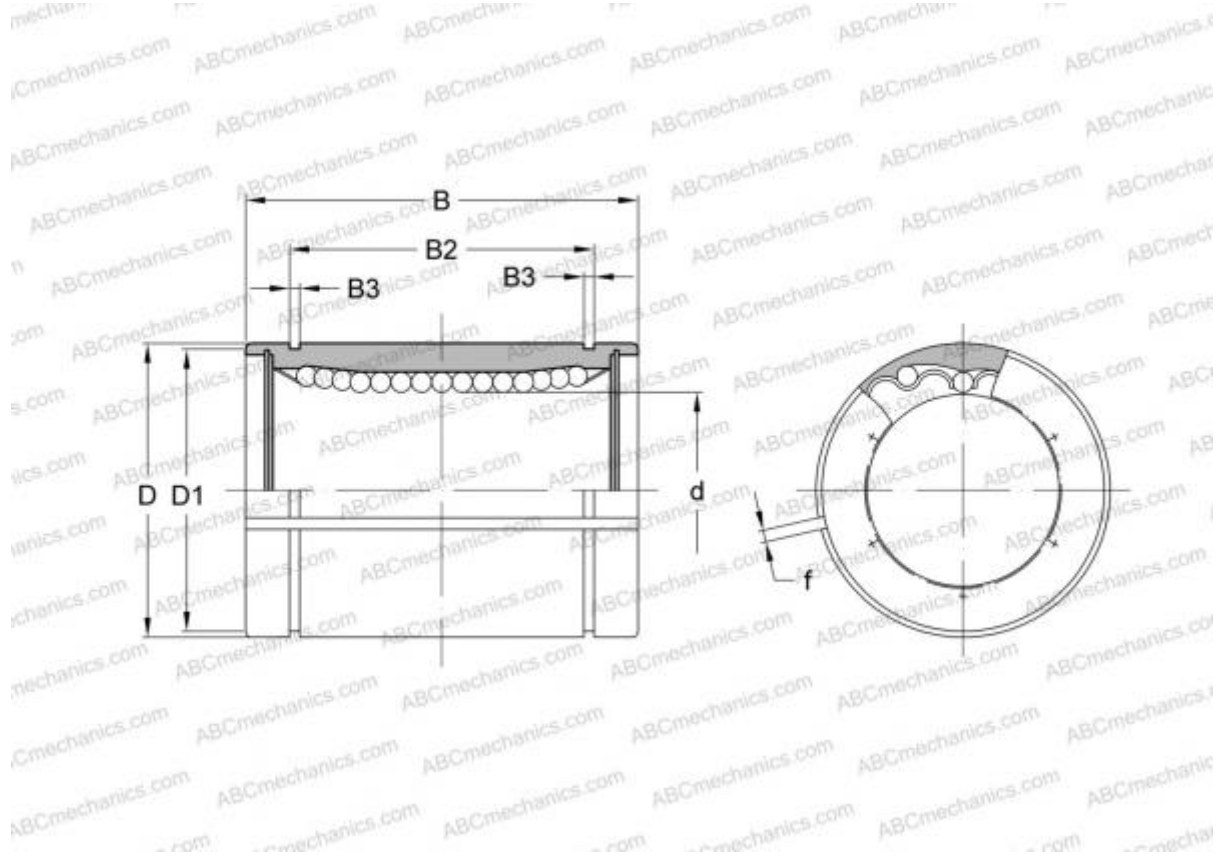

Technical specification

DIMENSIONS, MM

d	19,050
D	31,750
B	41,275
f	2,381

WEIGHT, KG 0,079

MANUFACTURER [HEIM](#)

INTERCHANGE

ABC	LBB 12 AJ
IKO	LBB 12 AJ
THOMSON	ADJ-122026