

ADJ-1000 HEIM

Linear bushing

TYPE: Shaft guidance systems, Linear bushing, Standard, Adjustable type, Type LBB..AJ, inch

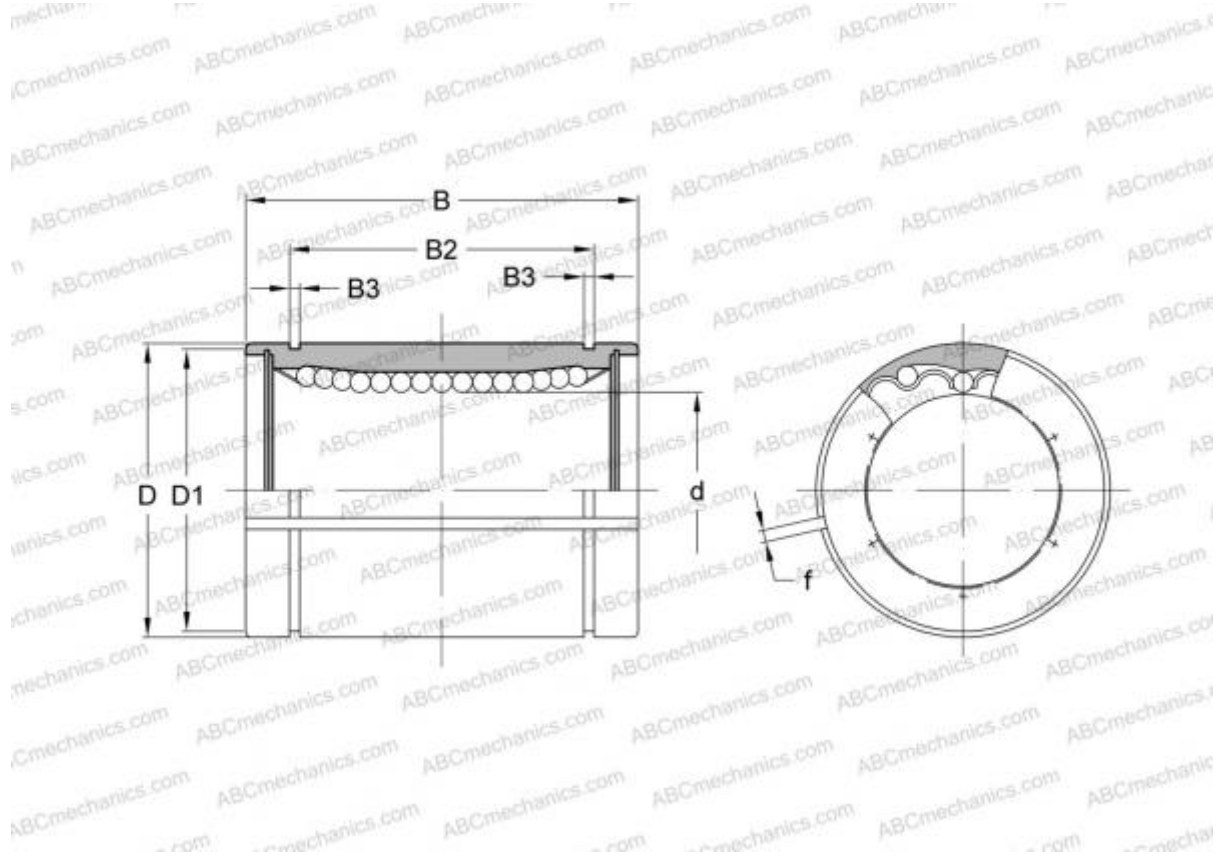

Technical specification

DIMENSIONS, MM

d	25,400
D	39,688
B	57,150
f	2,381

WEIGHT, KG 0,145

MANUFACTURER [HEIM](#)

INTERCHANGE

ABC	LBB 16 AJ
IKO	LBB 16 AJ
THOMSON	ADJ-162536