

LBB 24 AJ ABC

Linear bushing

TYPE: Shaft guidance systems, Linear bushing, Standard, Adjustable type, Type LBB..AJ, inch

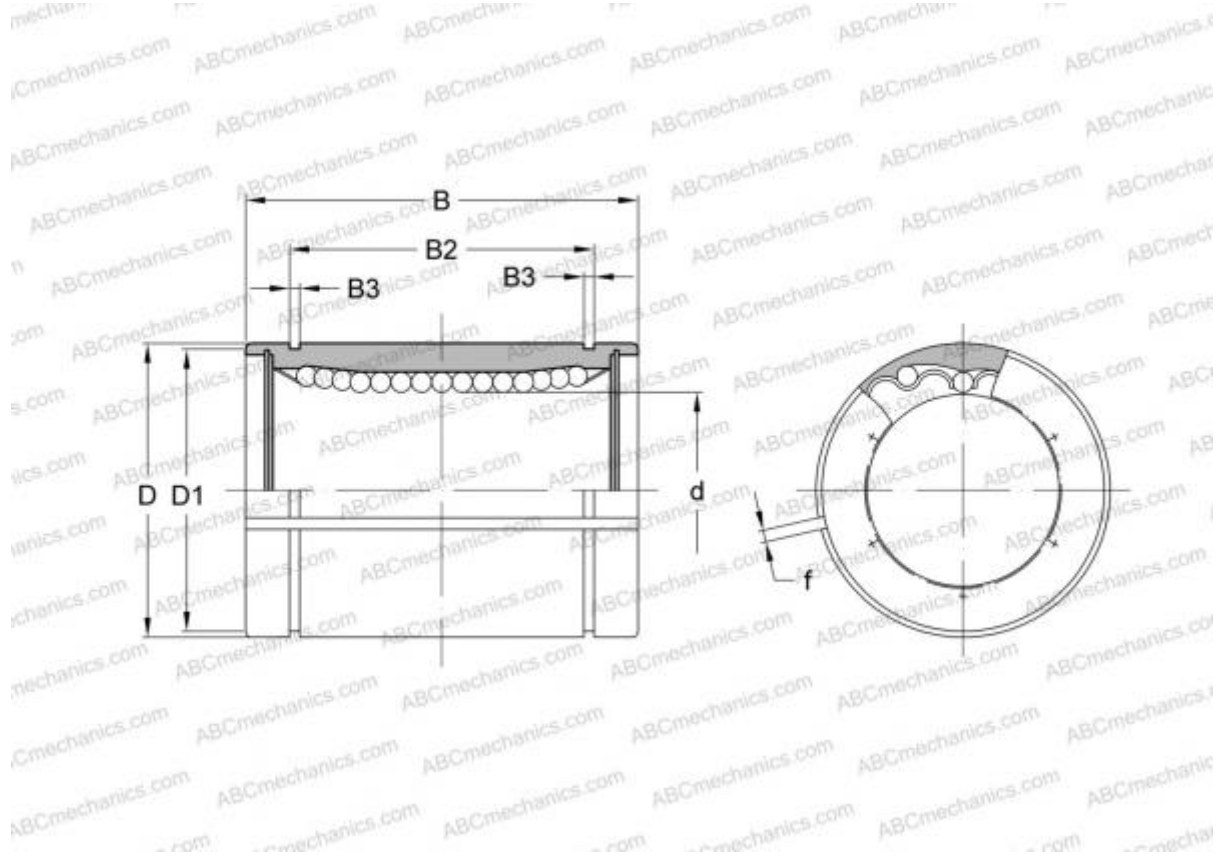

Technical specification

DIMENSIONS, MM

d	38,100
D	60,325
B	76,200
f	3,175

WEIGHT, KG 0,530

MANUFACTURER [ABC](#)

INTERCHANGE

IKO	LBB 24 AJ
THOMSON	ADJ-243848
HEIM	ADJ-1500