

## ADJ-1500 HEIM

Linear bushing

TYPE: Shaft guidance systems, Linear bushing, Standard, Adjustable type, Type LBB..AJ, inch

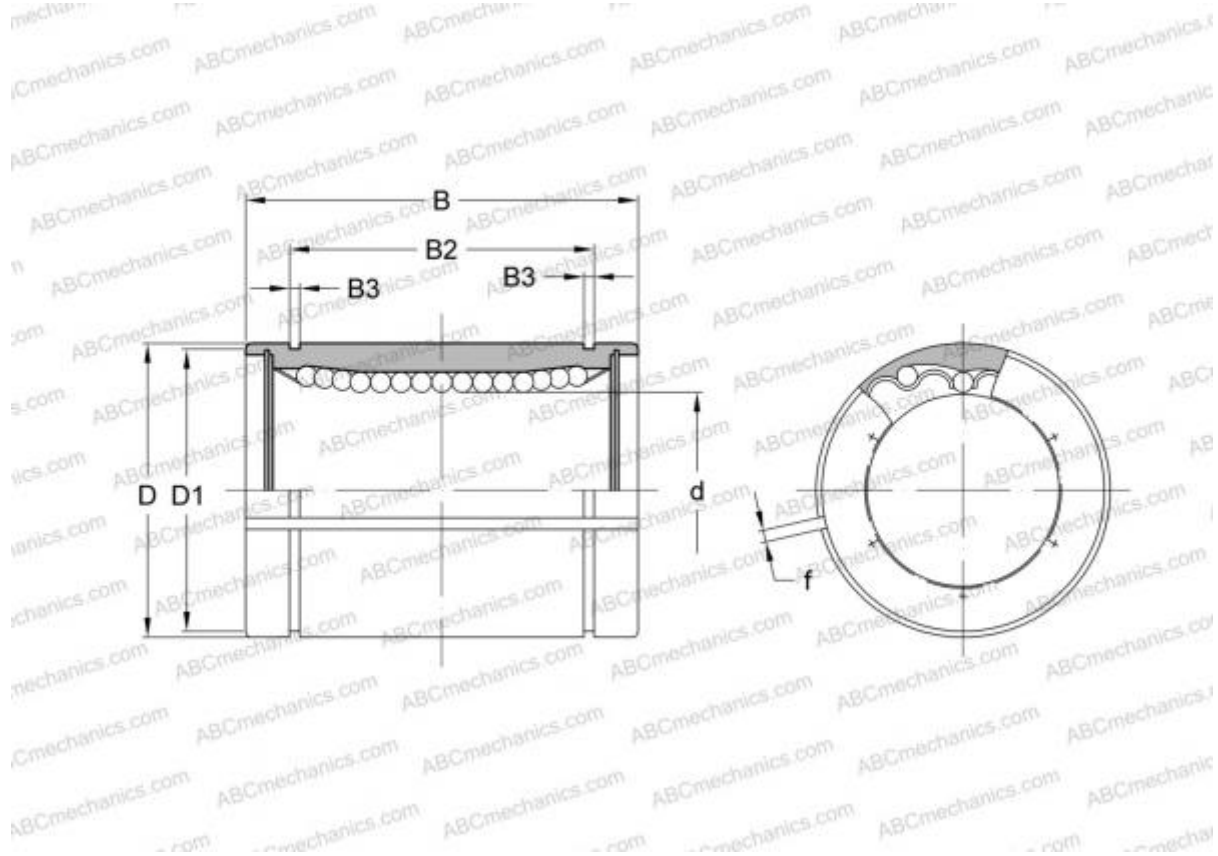

### Technical specification

#### DIMENSIONS, MM

d	38,100
D	60,325
B	76,200
f	3,175

**WEIGHT, KG** 0,530

**MANUFACTURER** [HEIM](#)

#### INTERCHANGE

ABC	<a href="#">LBB 24 AJ</a>
IKO	<a href="#">LBB 24 AJ</a>
THOMSON	<a href="#">ADJ-243848</a>