

## LBB 8 OP ABC

Linear bushing

TYPE: Shaft guidance systems, Linear bushing, Standard, Open type for support rail, Type LBB..OP, inch

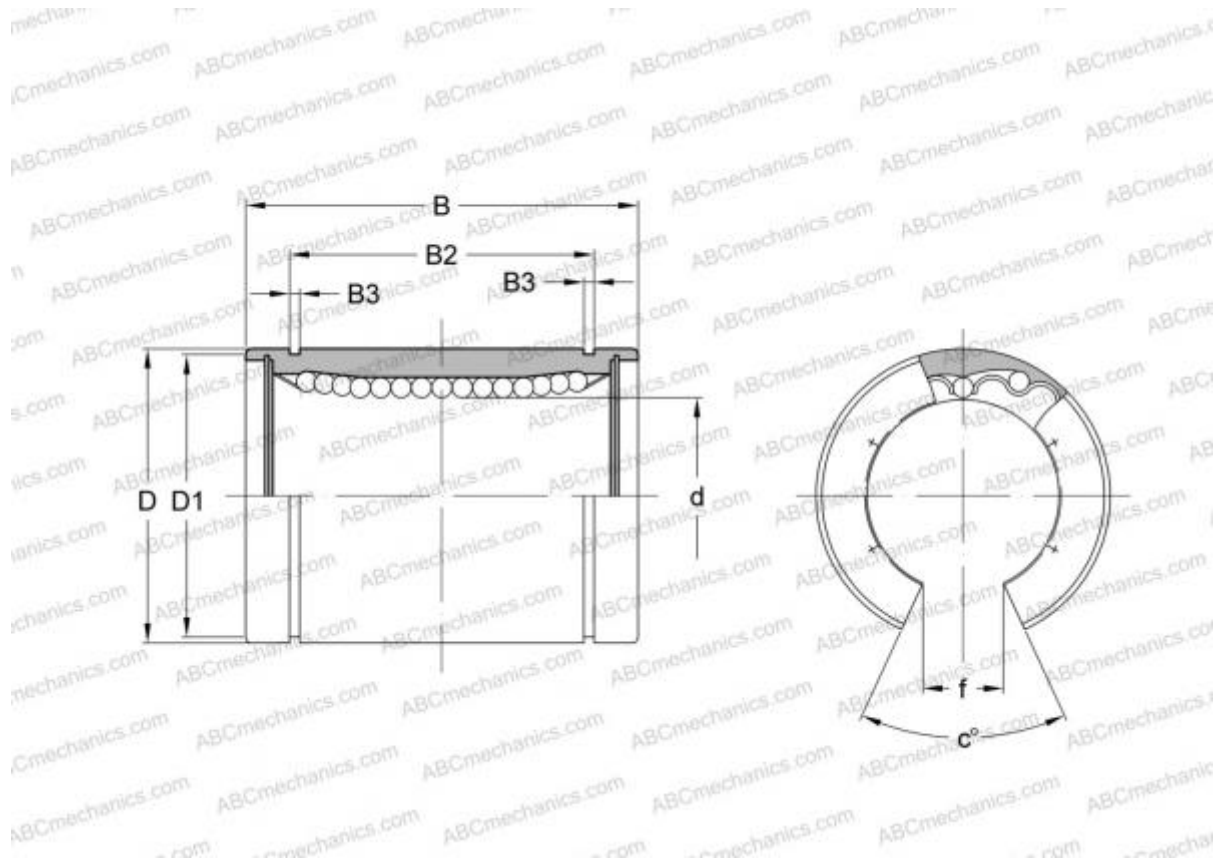

### Technical specification

#### DIMENSIONS, MM

d	12,700
D	22,225
B	31,750
f	7,938
c	50,000

**WEIGHT** 0,028

**MANUFACTURER** [ABC](#)

#### INTERCHANGE

IKO	<a href="#">LBB 8 OP</a>
THOMSON	<a href="#">OPN-81420</a>
HEIM	<a href="#">OPN-500</a>