

LBB 8 OP IKO

Linear bushing

TYPE: Shaft guidance systems, Linear bushing, Standard, Open type for support rail, Type LBB..OP, inch

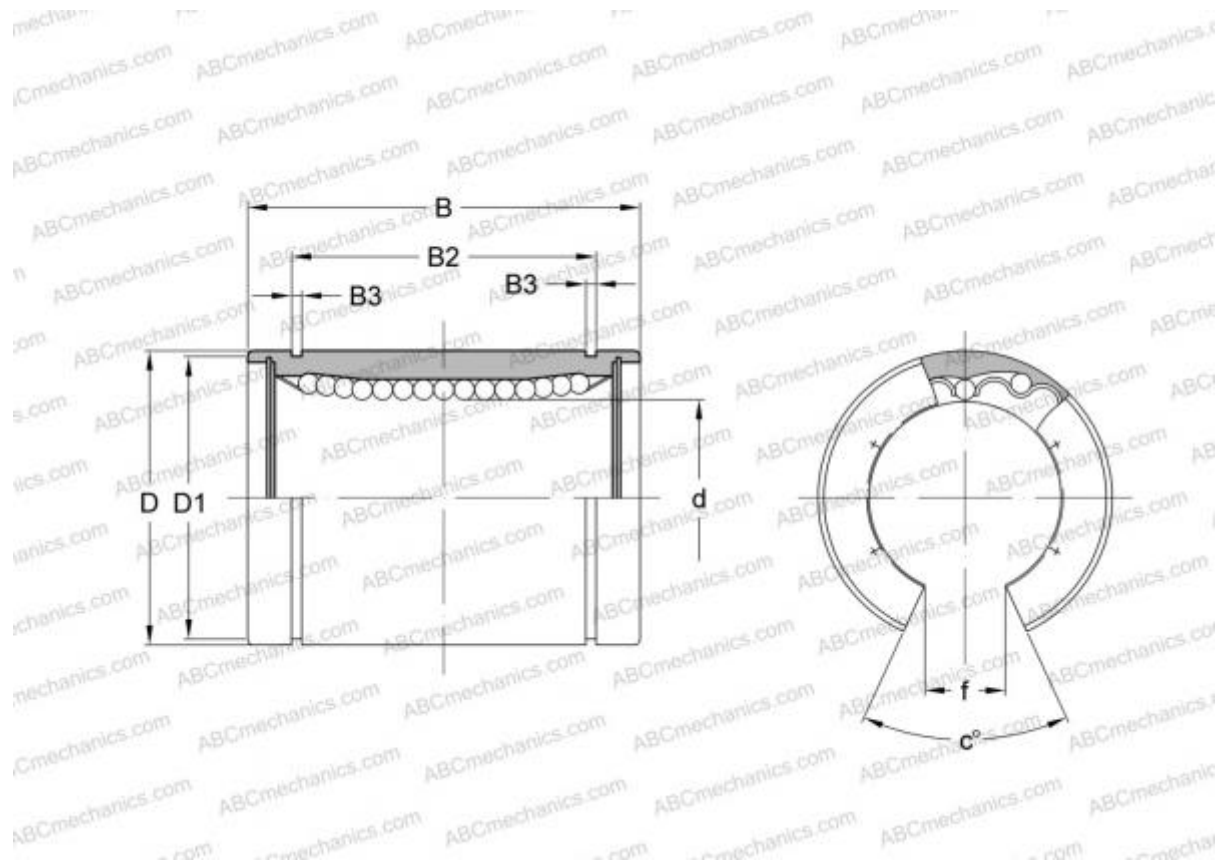

Technical specification

DIMENSIONS, MM

d	12,700
D	22,225
B	31,750
f	7,938
c	50,000

WEIGHT 0,028

MANUFACTURER [IKO](#)

INTERCHANGE

ABC	LBB 8 OP
THOMSON	OPN-81420
HEIM	OPN-500

CALCULATION DATA

Basic dynamic load rating min	0,290 kN
-------------------------------	----------

CALCULATION DATA

Basic dynamic load rating max	0,333 kN
Basic static load rating min	0,577 kN
Basic static load rating max	0,816 kN