

OPN-81420 THOMSON

Linear bushing

TYPE: Shaft guidance systems, Linear bushing, Standard, Open type for support rail, Type LBB..OP, inch

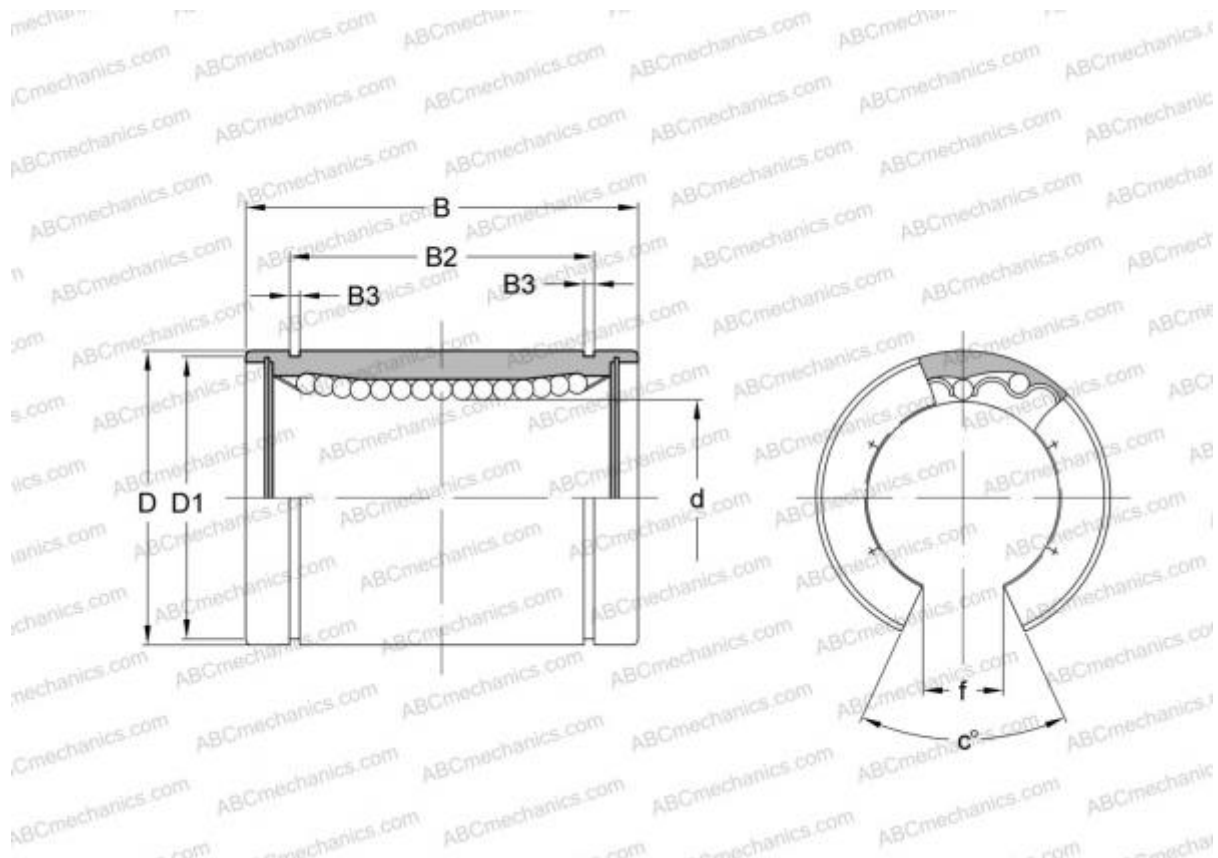

Technical specification

DIMENSIONS, MM

d	12,700
D	22,225
B	31,750
f	7,938
c	50,000

WEIGHT 0,028

MANUFACTURER [THOMSON](#)

INTERCHANGE

ABC	LBB 8 OP
IKO	LBB 8 OP
HEIM	OPN-500