

LBB 10 OP IKO

Linear bushing

TYPE: Shaft guidance systems, Linear bushing, Standard, Open type for support rail, Type LBB..OP, inch

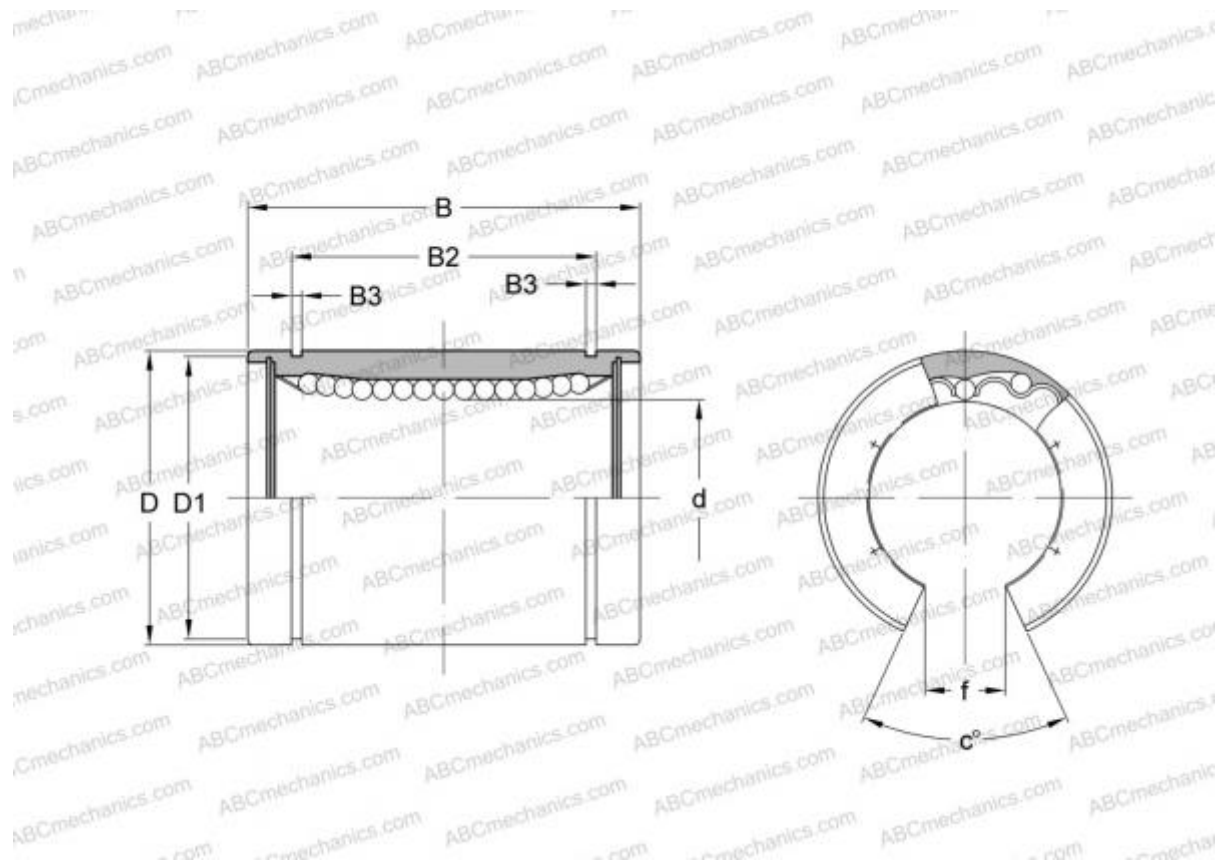

Technical specification

DIMENSIONS, MM

d	15,875
D	28,575
B	38,100
f	9,525
c	60,000

WEIGHT, KG 0,054

MANUFACTURER [IKO](#)

INTERCHANGE

ABC	LBB 10 OP
THOMSON	OPN-101824
HEIM	OPN-625

CALCULATION DATA

Basic dynamic load rating min	0,424 kN
-------------------------------	----------

CALCULATION DATA

Basic dynamic load rating max	0,488 kN
Basic static load rating min	0,766 kN
Basic static load rating max	1,080 kN