

OPN-625 HEIM

Linear bushing

TYPE: Shaft guidance systems, Linear bushing, Standard, Open type for support rail, Type LBB..OP, inch

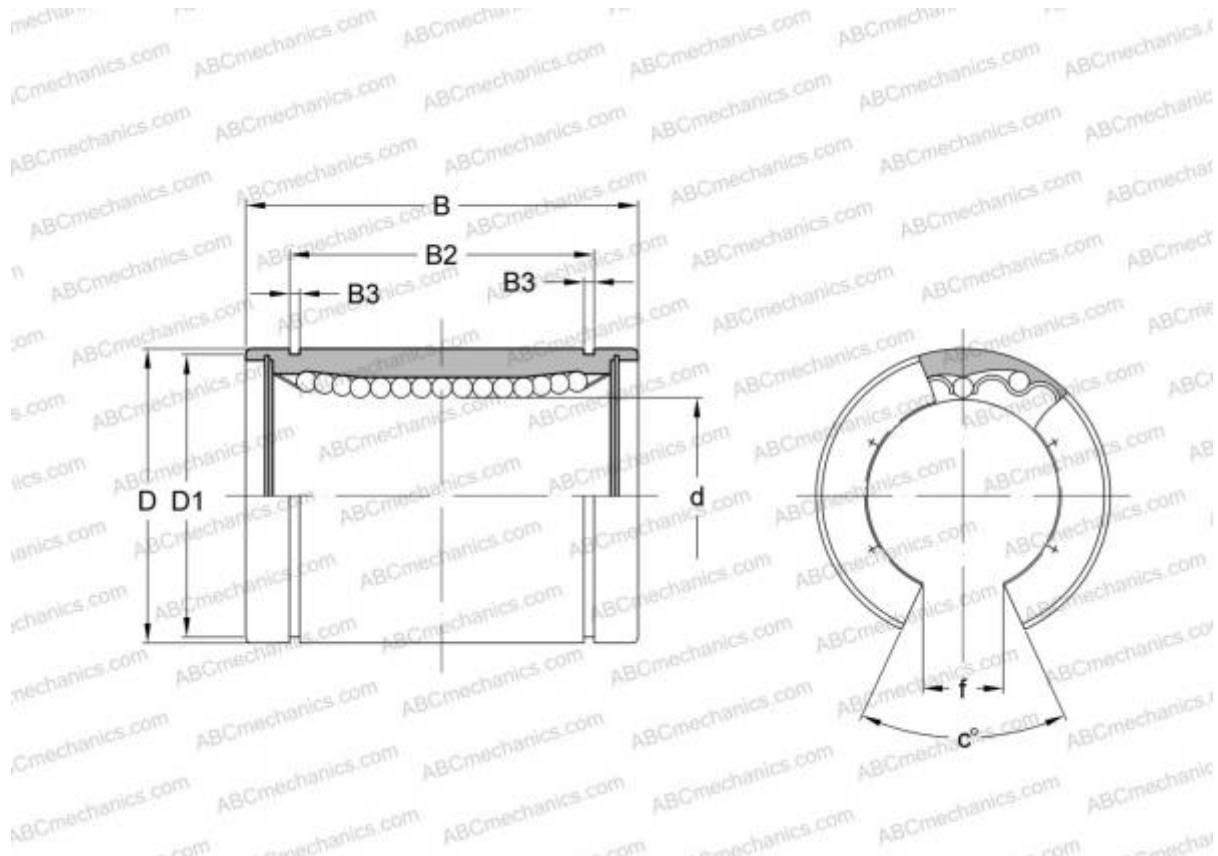

Technical specification

DIMENSIONS, MM

d	15,875
D	28,575
B	38,100
f	9,525
c	60,000

WEIGHT, KG 0,054

MANUFACTURER [HEIM](#)

INTERCHANGE

ABC	LBB 10 OP
IKO	LBB 10 OP
THOMSON	OPN-101824