

## LBB 12 OP ABC

Linear bushing

TYPE: Shaft guidance systems, Linear bushing, Standard, Open type for support rail, Type LBB..OP, inch

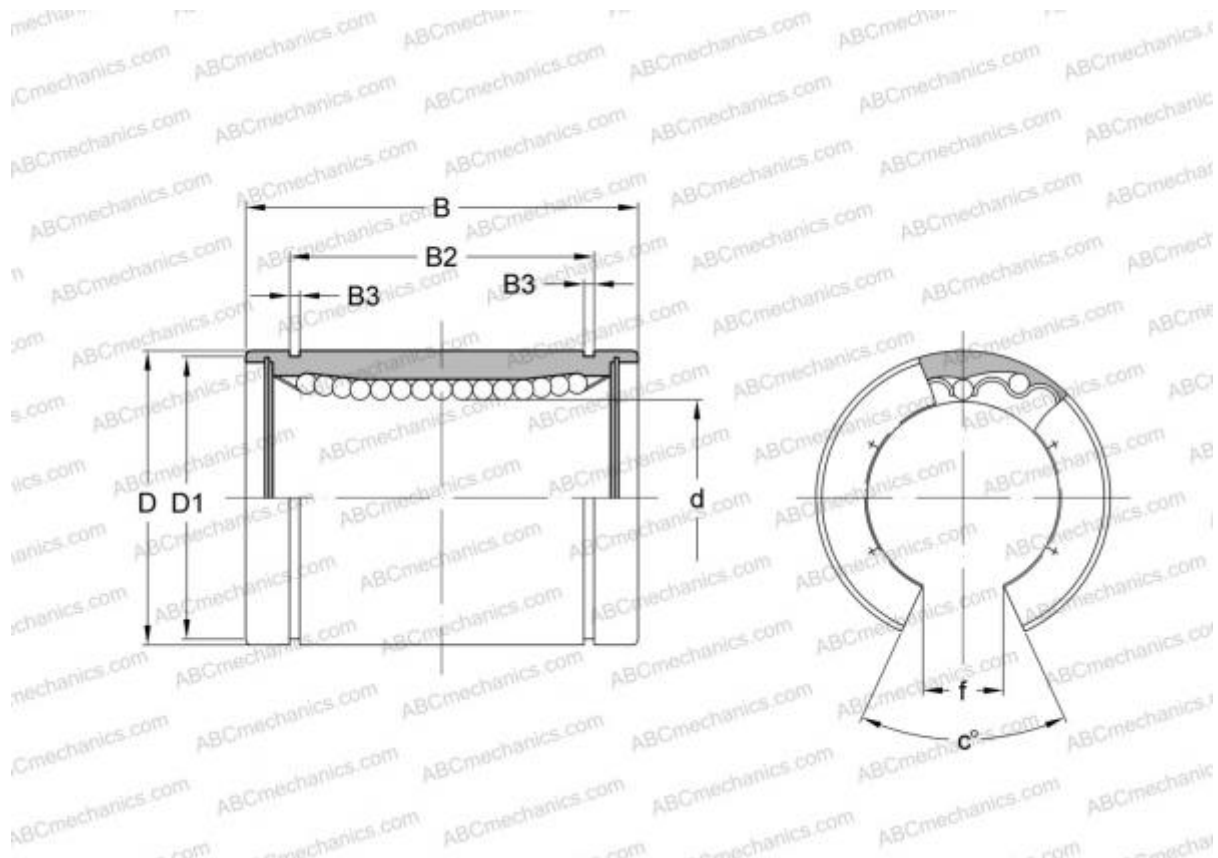

### Technical specification

#### DIMENSIONS, MM

d	19,050
D	31,750
B	41,275
f	11,112
c	60,000

**WEIGHT, KG** 0,069

**MANUFACTURER** [ABC](#)

#### INTERCHANGE

IKO	<a href="#">LBB 12 OP</a>
THOMSON	<a href="#">OPN-122026</a>
HEIM	<a href="#">OPN-750</a>