

OPN-750 HEIM

Linear bushing

TYPE: Shaft guidance systems, Linear bushing, Standard, Open type for support rail, Type LBB..OP, inch

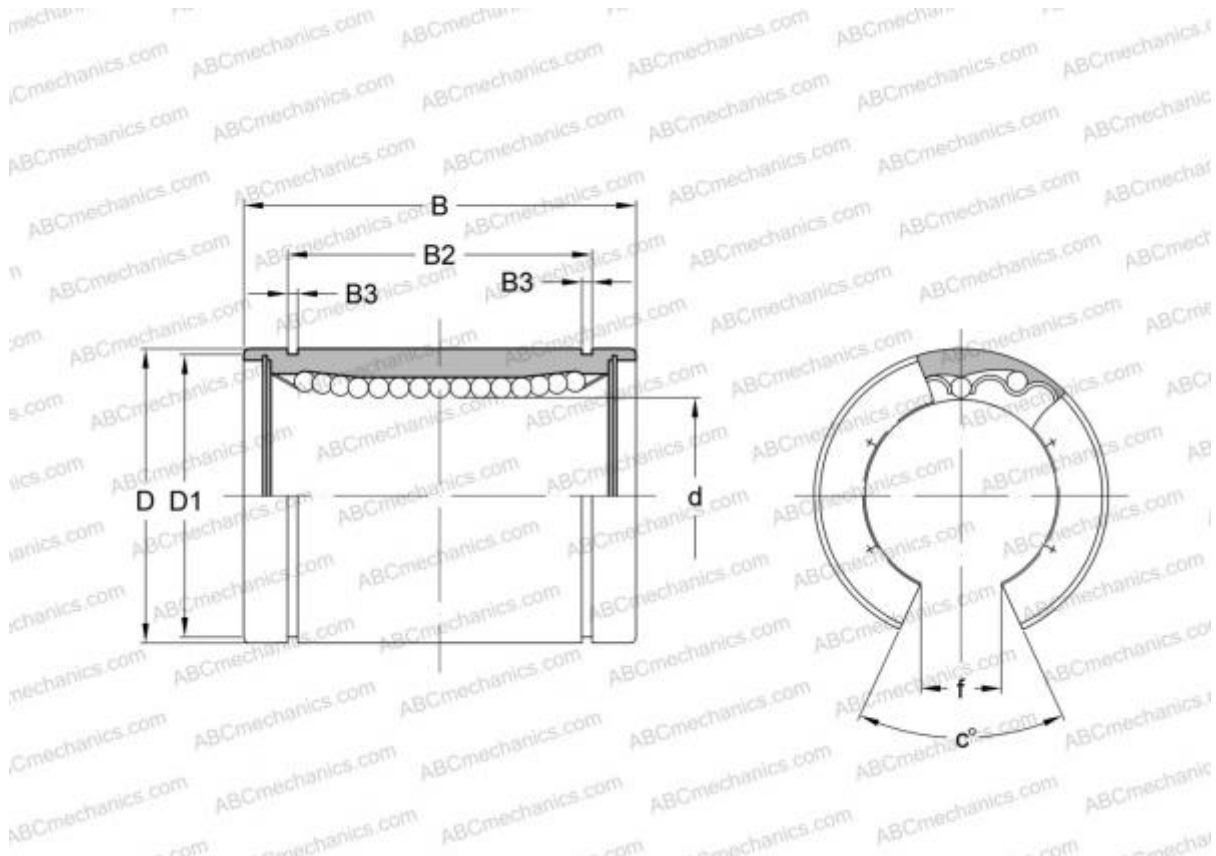

Technical specification

DIMENSIONS, MM

d	19,050
D	31,750
B	41,275
f	11,112
c	60,000

WEIGHT, KG 0,069

MANUFACTURER [HEIM](#)

INTERCHANGE

ABC	LBB 12 OP
IKO	LBB 12 OP
THOMSON	OPN-122026