

## LBB 20 OP IKO

Linear bushing

TYPE: Shaft guidance systems, Linear bushing, Standard, Open type for support rail, Type LBB..OP, inch

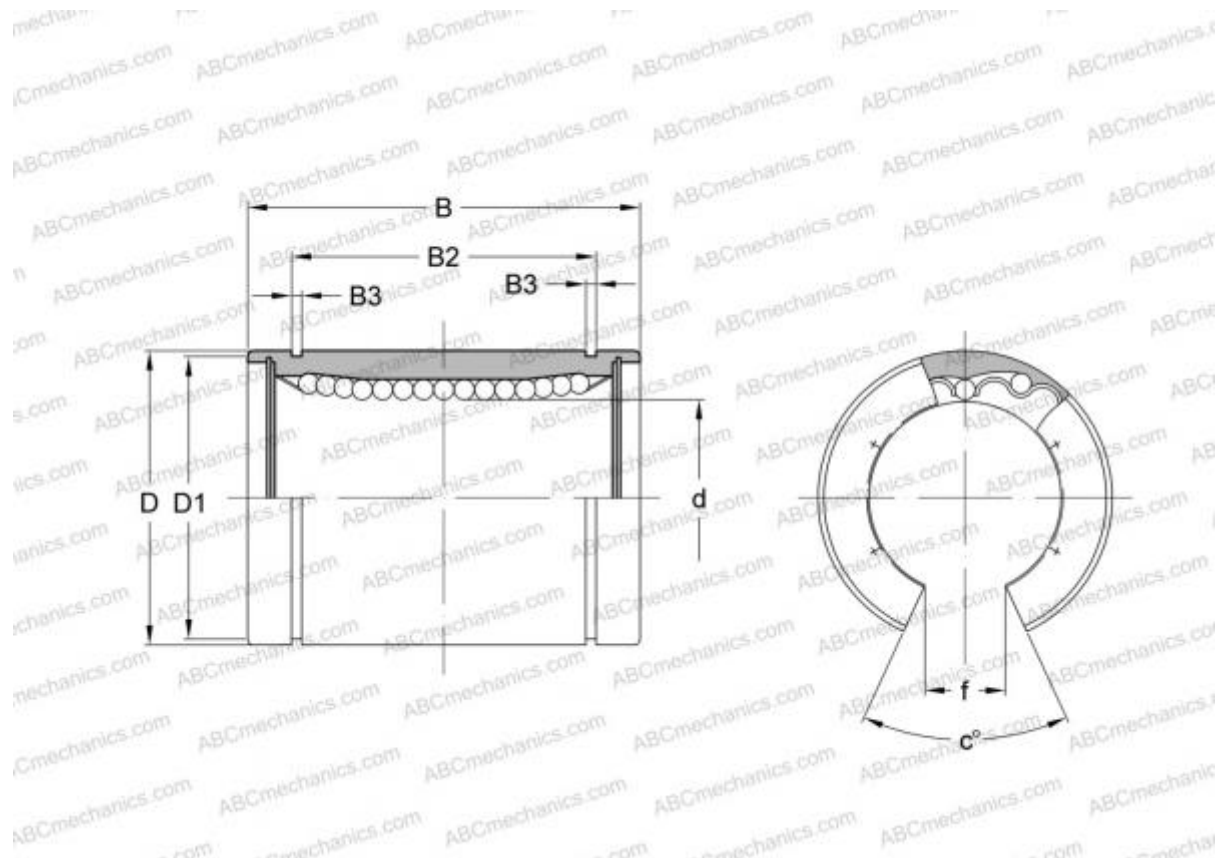

### Technical specification

#### DIMENSIONS, MM

d	31,750
D	50,800
B	66,675
f	15,875
c	50,000

**WEIGHT, KG** 0,285

**MANUFACTURER** [IKO](#)

#### INTERCHANGE

ABC	<a href="#">LBB 20 OP</a>
THOMSON	<a href="#">OPN-203242</a>
HEIM	<a href="#">OPN-1250</a>

#### CALCULATION DATA

Basic dynamic load rating min	1,920 kN
-------------------------------	----------

#### CALCULATION DATA

Basic dynamic load rating max	2,030 kN
Basic static load rating min	3,570 kN
Basic static load rating max	4,570 kN