

OPN-203242 THOMSON

Linear bushing

TYPE: Shaft guidance systems, Linear bushing, Standard, Open type for support rail, Type LBB..OP, inch

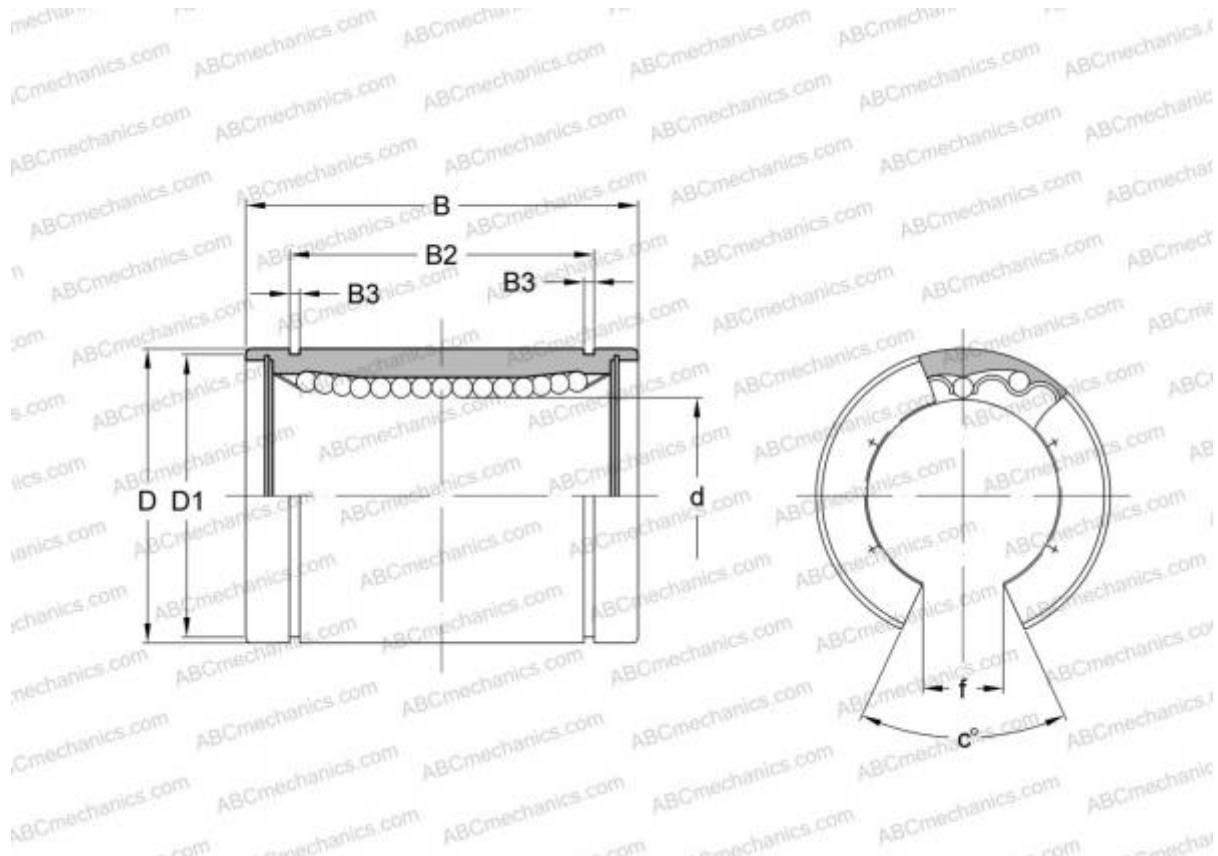

Technical specification

DIMENSIONS, MM

d	31,750
D	50,800
B	66,675
f	15,875
c	50,000

WEIGHT, KG 0,285

MANUFACTURER [THOMSON](#)

INTERCHANGE

ABC	LBB 20 OP
IKO	LBB 20 OP
HEIM	OPN-1250