

## LBB 24 OP ABC

Linear bushing

TYPE: Shaft guidance systems, Linear bushing, Standard, Open type for support rail, Type LBB..OP, inch

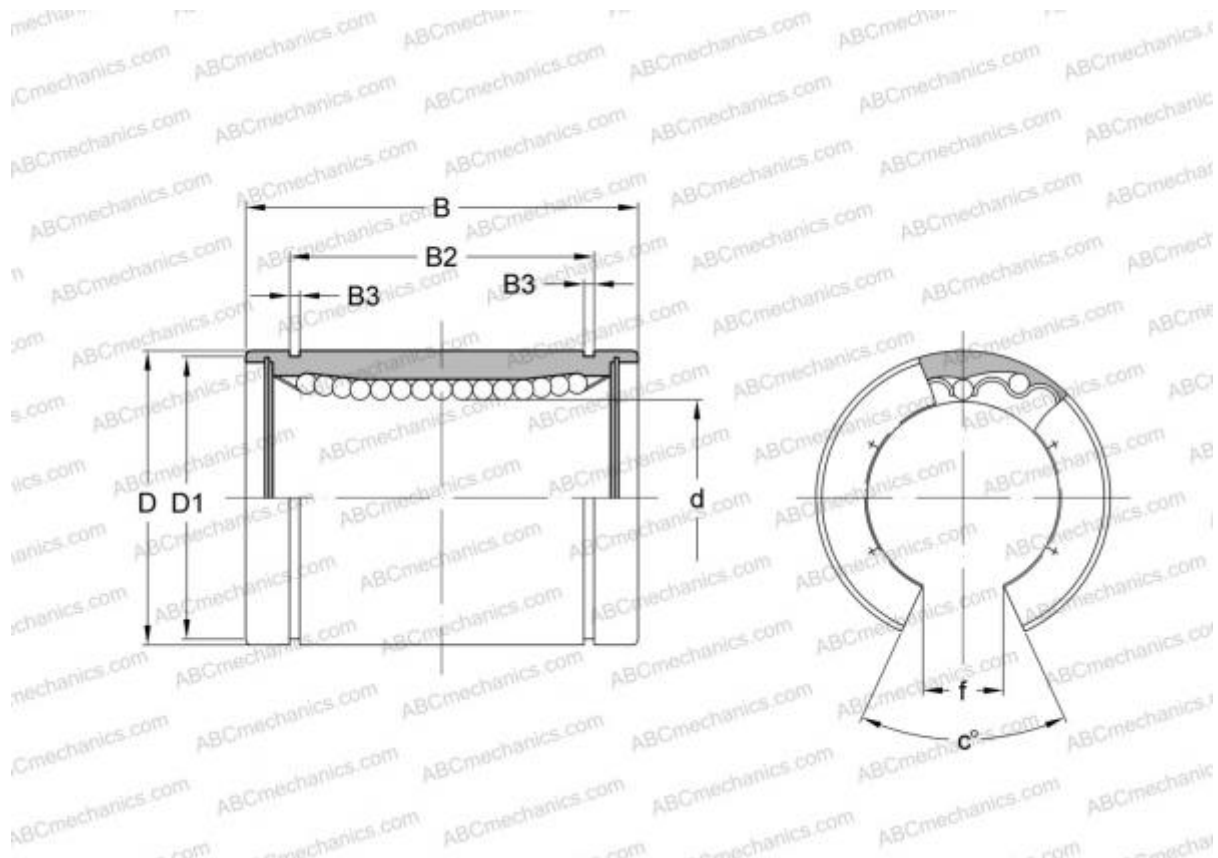

### Technical specification

#### DIMENSIONS, MM

d	38,100
D	60,325
B	76,200
f	19,050
c	50,000

**WEIGHT, KG** 0,470

**MANUFACTURER** [ABC](#)

#### INTERCHANGE

IKO	<a href="#">LBB 24 OP</a>
THOMSON	<a href="#">OPN-243848</a>
HEIM	<a href="#">OPN-1500</a>