

OPN-243848 THOMSON

Linear bushing

TYPE: Shaft guidance systems, Linear bushing, Standard, Open type for support rail, Type LBB..OP, inch

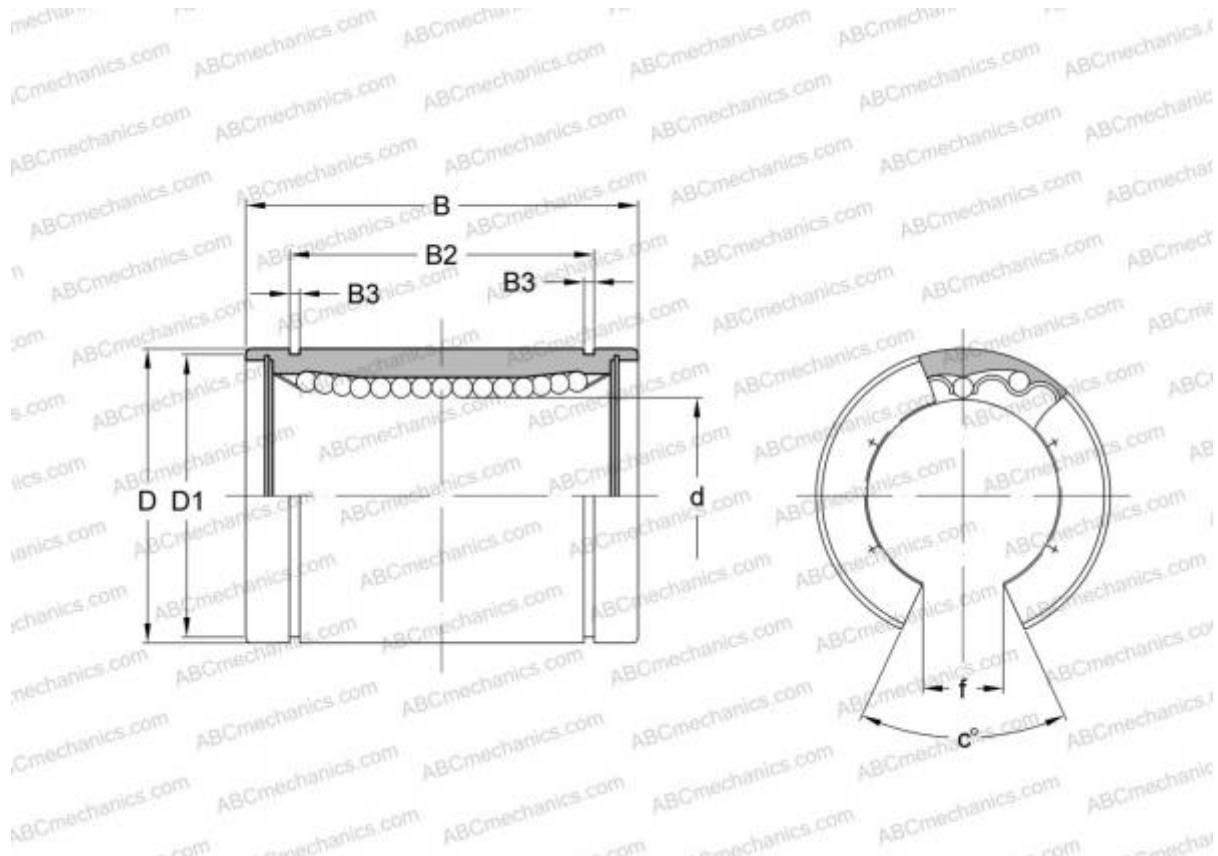

Technical specification

DIMENSIONS, MM

d	38,100
D	60,325
B	76,200
f	19,050
c	50,000

WEIGHT, KG 0,470

MANUFACTURER [THOMSON](#)

INTERCHANGE

ABC	LBB 24 OP
IKO	LBB 24 OP
HEIM	OPN-1500