

LBB 6 UU ABC

Linear bushing

TYPE: Shaft guidance systems, Linear bushing, Standard, Close type, Type LBB..UU, sealed on both sides, inch

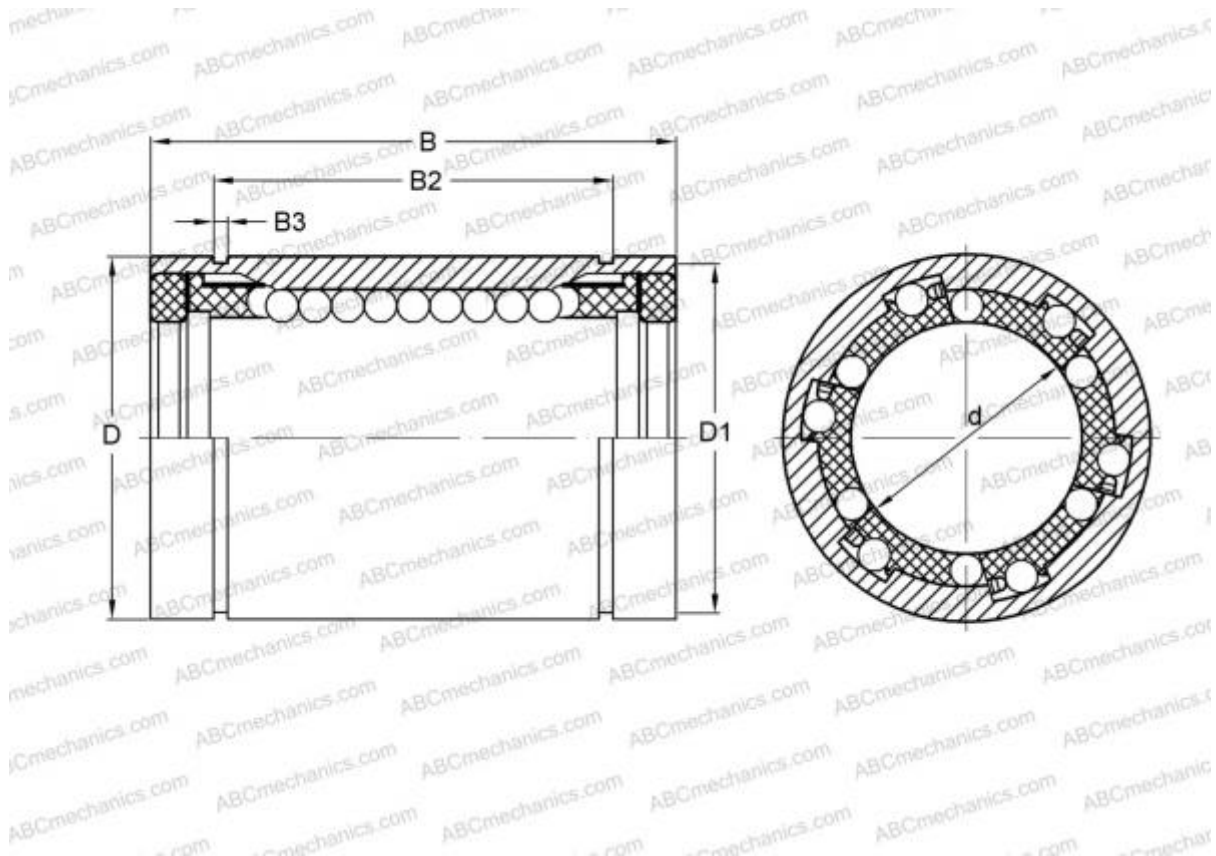

Technical specification

DIMENSIONS, MM

d	9,525
D	15,875
B	22,225

WEIGHT 0,010

MANUFACTURER [ABC](#)

INTERCHANGE

IKO	LBB 6 UU
HEIM	LBB-375 PP