

LBB 10 UU ABC

Linear bushing

TYPE: Shaft guidance systems, Linear bushing, Standard, Close type, Type LBB..UU, sealed on both sides, inch

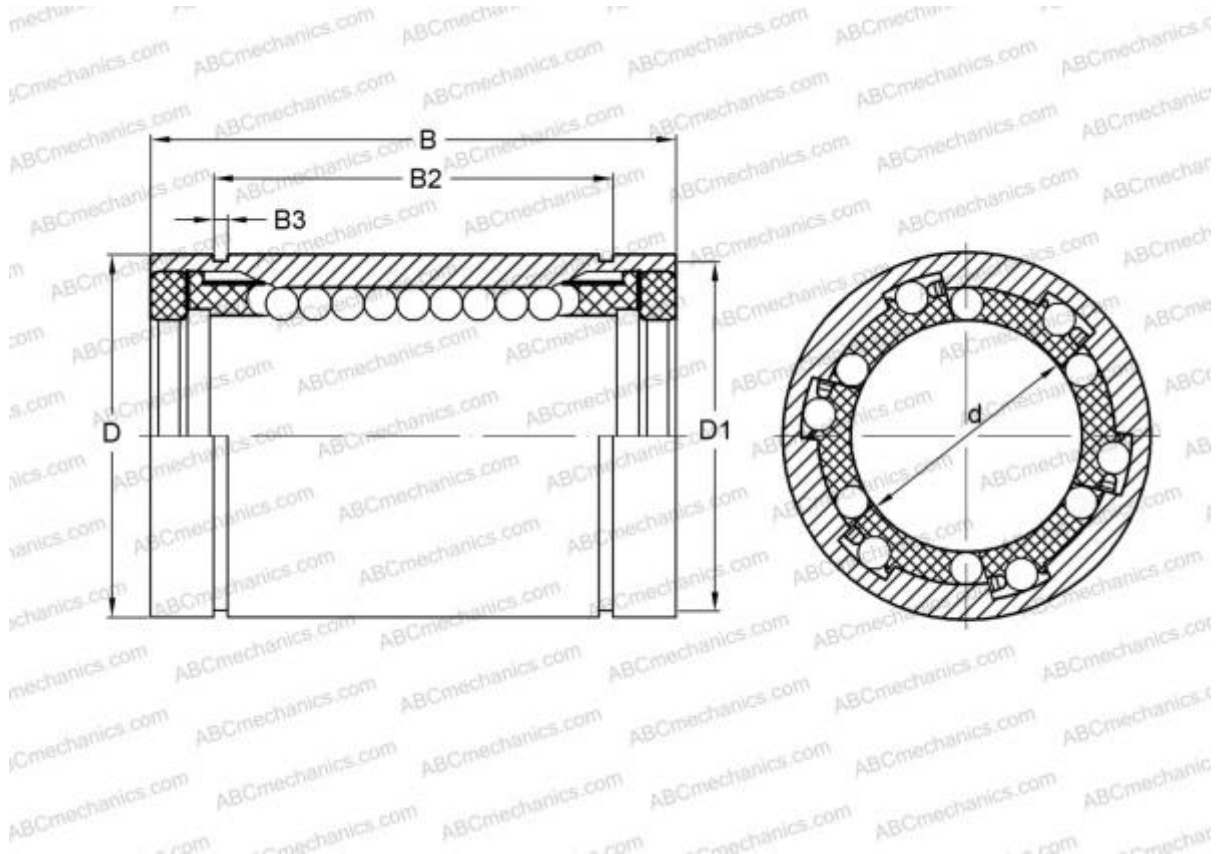

Technical specification

DIMENSIONS, MM

d	15,875
D	28,575
B	38,100

WEIGHT, KG 0,065

MANUFACTURER [ABC](#)

INTERCHANGE

IKO	LBB 10 UU
HEIM	LBB-625 PP