

## LBB 8 UU AJ ABC

Linear bushing

TYPE: Shaft guidance systems, Linear bushing, Standard, Adjustable type, Type LBB..UU AJ, sealed on both sides, inch

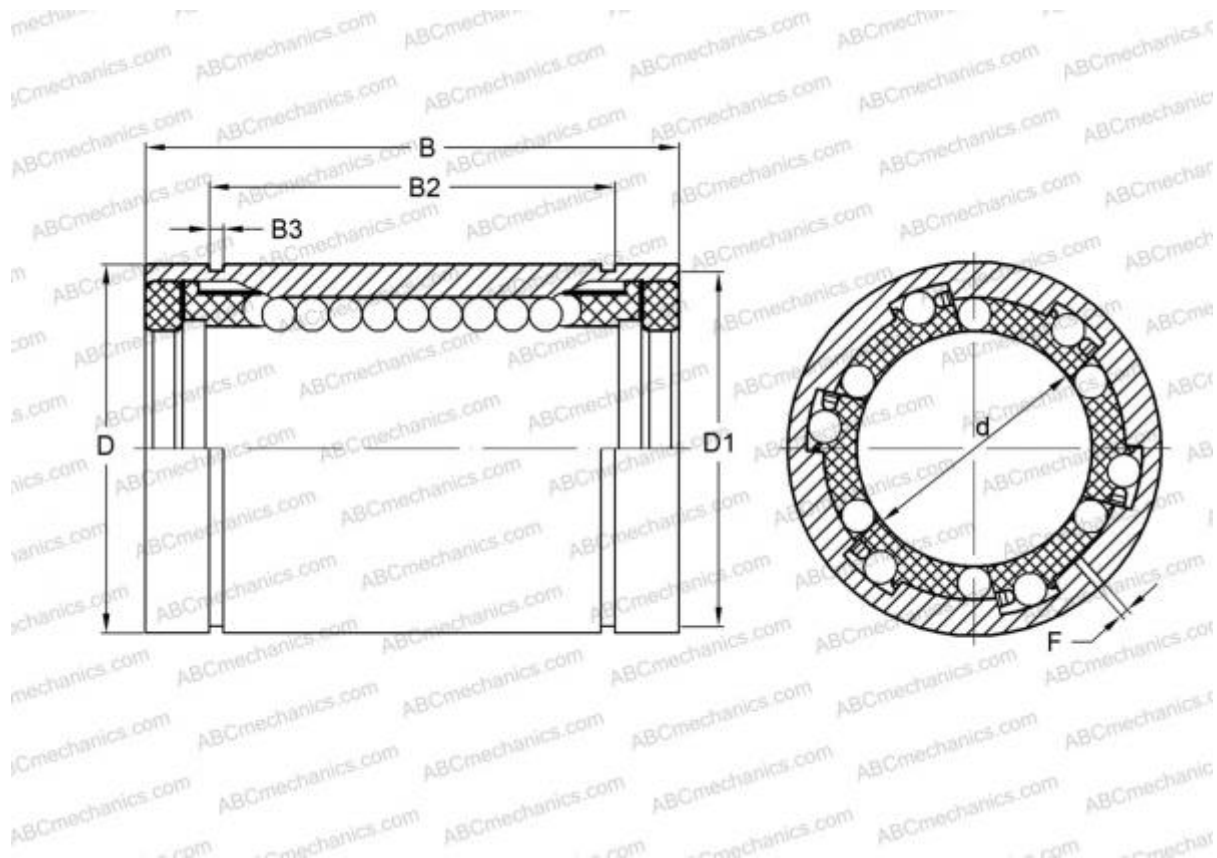

### Technical specification

#### DIMENSIONS, MM

d	12,700
D	22,225
B	31,750
f	1,588

**WEIGHT, KG** 0,032

**MANUFACTURER** [ABC](#)

#### INTERCHANGE

IKO	<a href="#">LBB 8 UU AJ</a>
HEIM	<a href="#">ADJ-500 PP</a>