

LBB 8 UU AJ IKO

Linear bushing

TYPE: Shaft guidance systems, Linear bushing, Standard, Adjustable type, Type LBB..UU AJ, sealed on both sides, inch

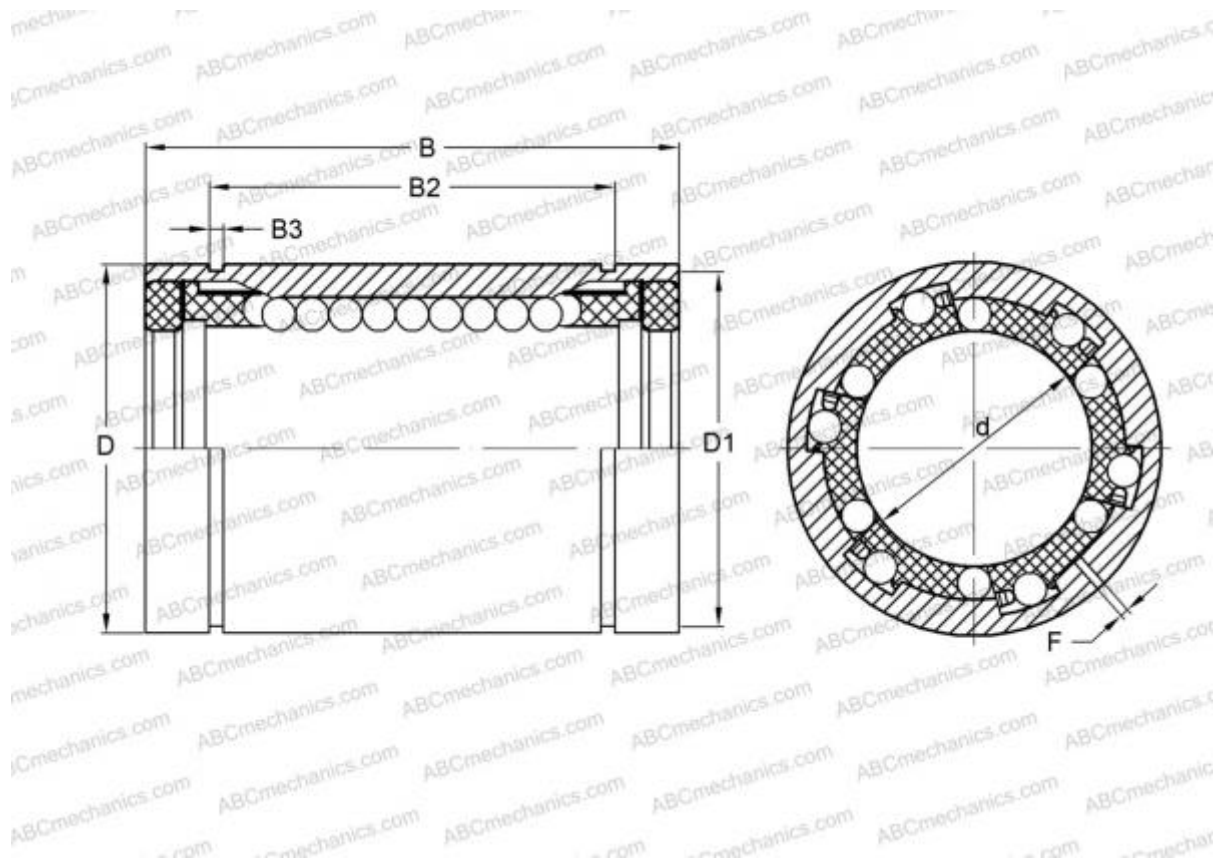

Technical specification

DIMENSIONS, MM

d	12,700
D	22,225
B	31,750
f	1,588

WEIGHT, KG 0,032

MANUFACTURER [IKO](#)

INTERCHANGE

ABC	LBB 8 UU AJ
HEIM	ADJ-500 PP

CALCULATION DATA

Basic dynamic load rating min	0,290 kN
Basic dynamic load rating max	0,333 kN
Basic static load rating min	0,577 kN

CALCULATION DATA

Basic static load rating max	0,816 kN
------------------------------	----------