

LBB 8 UU OP ABC

Linear bushing

TYPE: Shaft guidance systems, Linear bushing, Standard, Open type for support rail, Type LBB..UU OP, sealed on both sides, inch

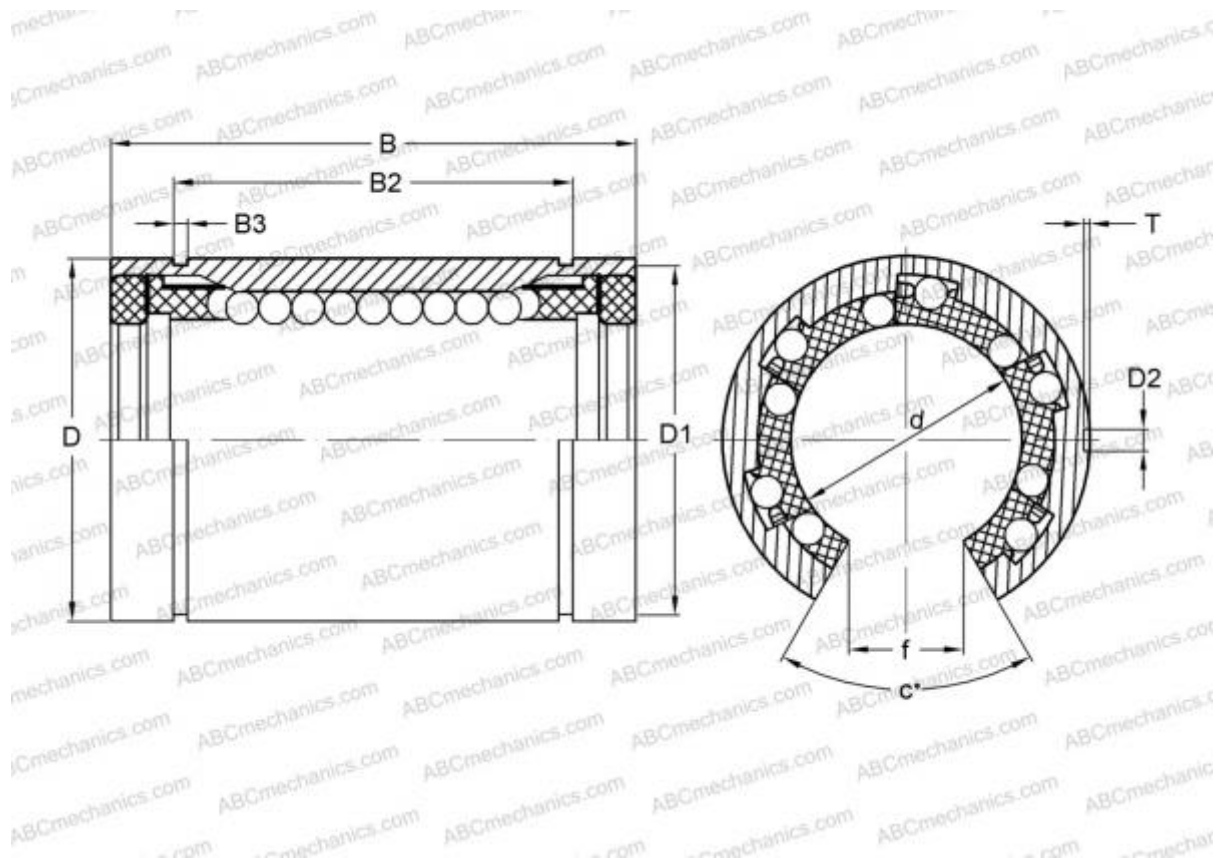

Technical specification

DIMENSIONS, MM

d	12,700
D	22,225
B	31,750
f	7,938
c	50,000

WEIGHT 0,028

MANUFACTURER [ABC](#)

INTERCHANGE

IKO	LBB 8 UU OP
HEIM	OPN-500 PP