

SMS 35G NB

Linear bushing

TYPE: Shaft guidance systems, Linear bushing, Standard, Close type, Type SM, Asian standard, Corrosion resistance, Plastic cage (NB)

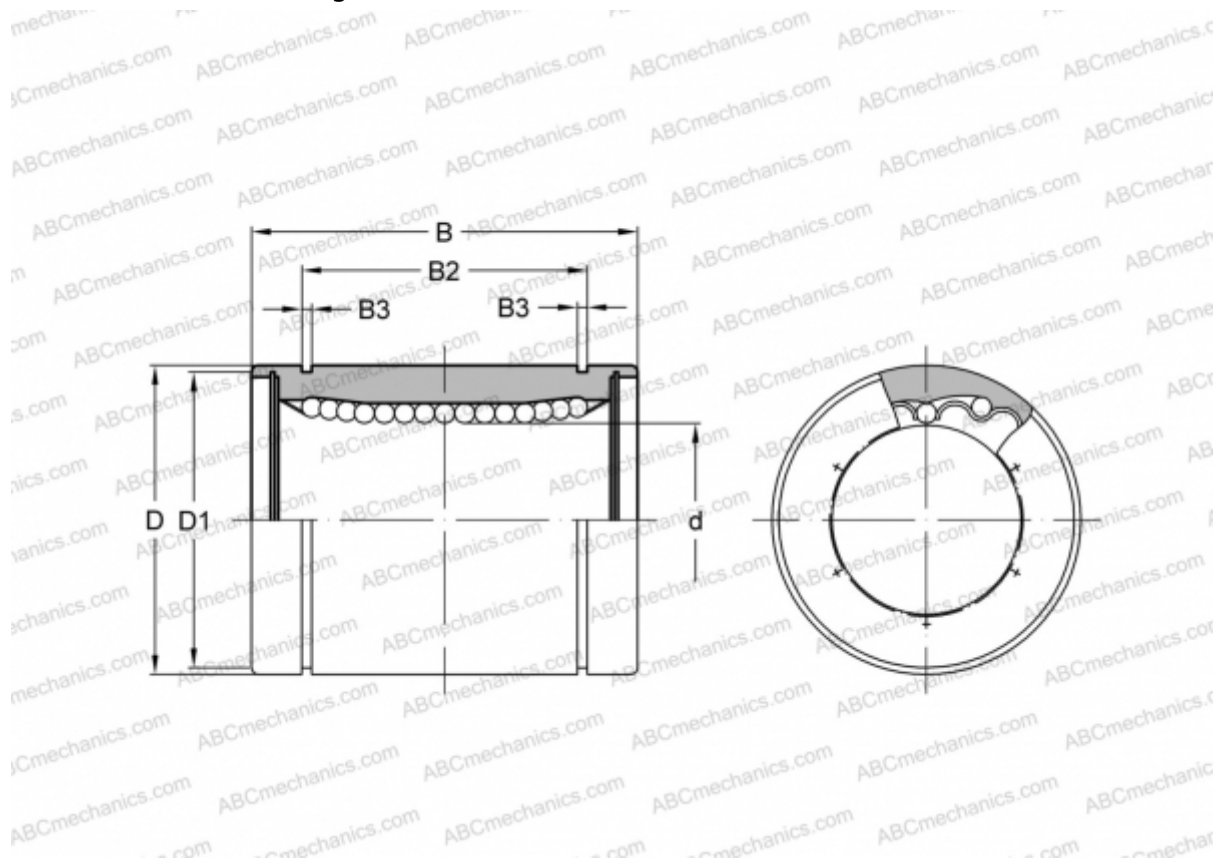

Technical specification

DIMENSIONS, MM

d	35,000
D	52,000
B	70,000
D1	49,000
B2	49,500
B3	2,100

WEIGHT, KG 0,425

MANUFACTURER [NB](#)