

LBB 8 UU OP IKO

Linear bushing

TYPE: Shaft guidance systems, Linear bushing, Standard, Open type for support rail, Type LBB..UU OP, sealed on both sides, inch

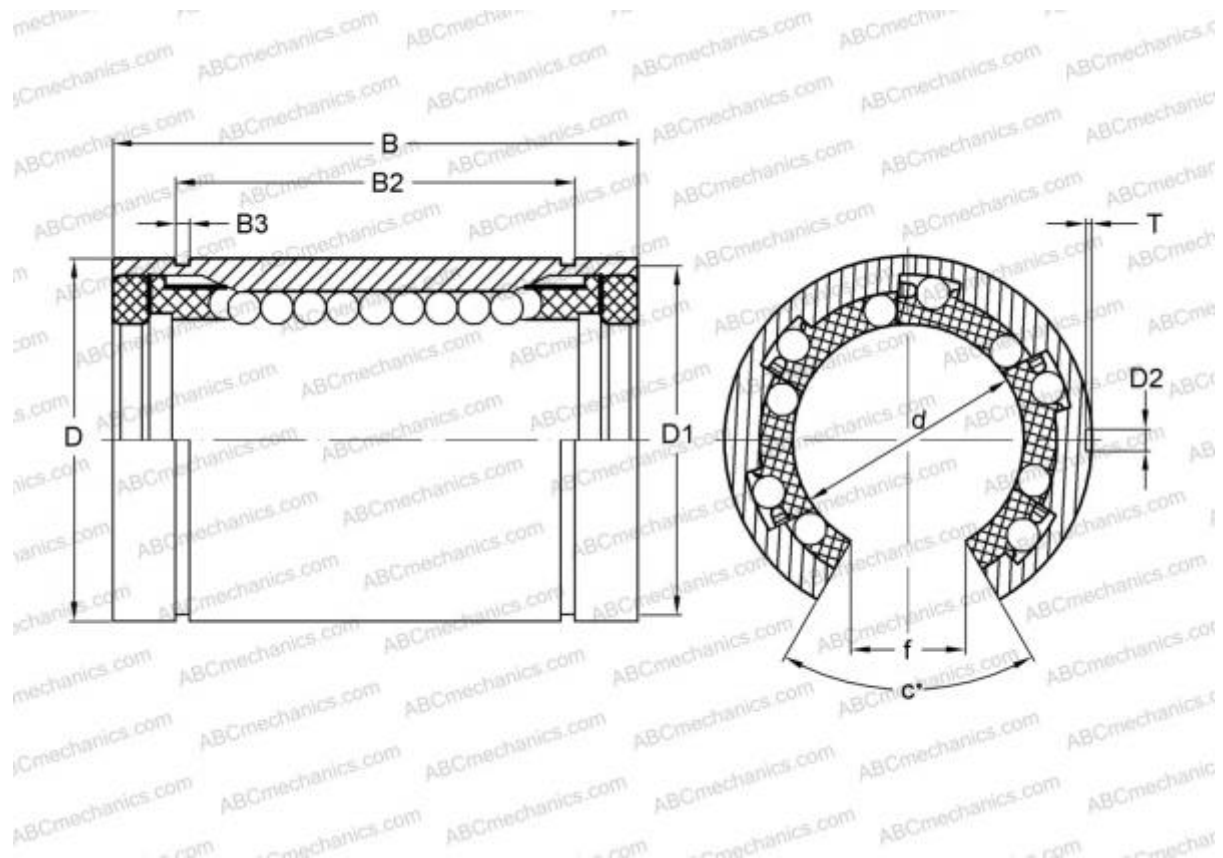

Technical specification

DIMENSIONS, MM

d	12,700
D	22,225
B	31,750
f	7,938
c	50,000

WEIGHT 0,028

MANUFACTURER [IKO](#)

INTERCHANGE

ABC	LBB 8 UU OP
HEIM	OPN-500 PP

CALCULATION DATA

Basic dynamic load rating min	0,290 kN
Basic dynamic load rating max	0,333 kN

CALCULATION DATA

Basic static load rating min	0,577 kN
Basic static load rating max	0,816 kN